

Application Manual

TUNS 50/100

Cosel

Our company network supports you worldwide with offices in Germany, Austria, Switzerland, Great Britain and the USA. For more information please contact:

FORTEC Elektronik AG

Hauptniederlassung
Lechwiesenstr. 9
86899 Landsberg am Lech

Telefon: +49 (0) 8191 91172-0

Telefax: +49 (0) 8191 21770

E-Mail: sales@fortecag.de

Internet: www.fortecag.de

FORTEC Elektronik AG

Büro Nord
Am Hasenkamp 36
22457 Hamburg

Telefon: +49 (0) 40 54 80 56 11

Telefax: +49 (0) 40 54 80 56 13

E-Mail: nord@fortecag.de

Internet: www.fortecag.de

FORTEC Elektronik AG

Büro West
Hohenstaufenring 55
50674 Köln

Telefon: +49 (0) 221 272 273-0

Telefax: +49 (0) 221 272 273-10

E-Mail: west@fortecag.de

Internet: www.fortecag.de

FORTEC Elektronik AG

Büro Wien
Nuschinggasse 12
A-1230 Wien

Telefon: +43 1 8673492-0

Telefax: +43 1 8673492-26

E-Mail: office@fortec.at

Internet: www.fortec.at

ALTRAC AG

(Tochter der FORTEC):
Bahnhofstraße 3
CH-5436 Würenlos

Telefon: +41 (0) 44 7446111

Telefax: +41 (0) 44 7446161

E-Mail: info@altrac.ch

Internet: www.altrac.ch

The information contained in this document has been carefully researched and is, to the best of our knowledge, accurate. However, we assume no liability for any product failures or damages, immediate or consequential, resulting from the use of the information provided herein. Our products are not intended for use in systems in which failures of product could result in personal injury. All trademarks mentioned herein are property of their respective owners. All specifications are subject to change without notice.

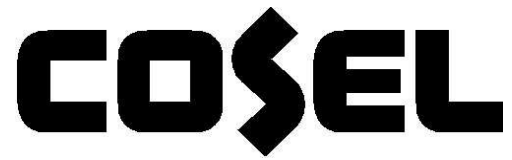

Applications Manual for TUNS50/100

TUNS50/100 series



Contents

| | | Page |
|--|---|------|
| 1. Pin Assignment | | A-1 |
| 2. Connection for Standard Use | | A-2 |
| 2.1 | Connection for standard use | A-2 |
| 2.2 | Input fuse : F11 | A-3 |
| 2.3 | Input capacitor : C11 | A-3 |
| 2.4 | Y capacitors and noise filters : CY,CX,L1 | A-4 |
| 2.5 | Output capacitors : Co,C40 | A-4 |
| 2.6 | Smoothing capacitor for boost voltage : Cbc | A-5 |
| 2.7 | Capacitor for boost voltage : C20 | A-5 |
| 2.8 | Inrush current limiting thermistor : TH11 | A-6 |
| 3. Derating | | A-7 |
| 3.1 | Input voltage derating | A-7 |
| 3.2 | Output current derating | A-7 |
| 4. Operation under low temperature conditions | | A-8 |
| 4.1 | Outline of low temperature operation | A-8 |
| 4.2 | Improvement of unstable operation | A-9 |
| 4.3 | Relationship between unstable operation and input voltage | A-9 |
| 5. Holdup time | | A-10 |
| Appendix | | |

1 Pin Assignment

Fig.1.1
Pin configuration
(bottom view)

● TUNS50

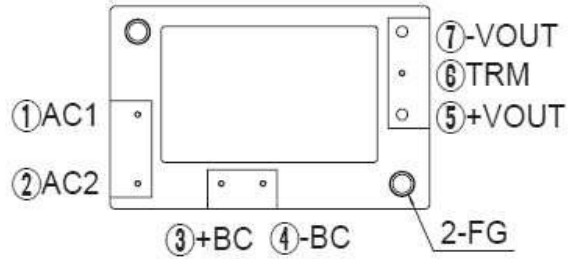

● TUNS100

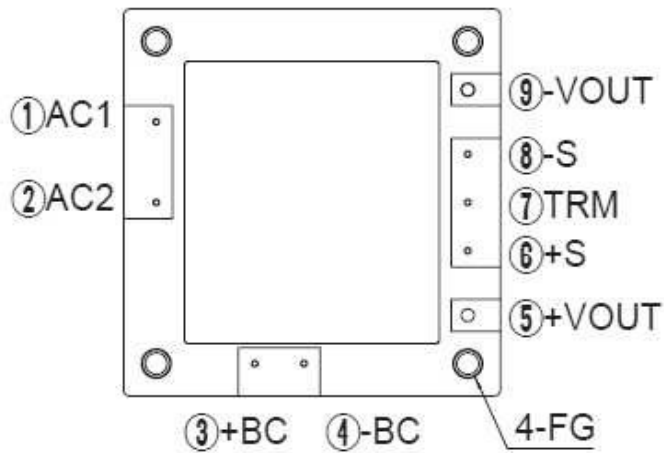

Table 1.1
Pin configuration
and function

| No. | | Pin Connection | Function |
|--------|---------|----------------|------------------------------|
| TUNS50 | TUNS100 | | |
| ① | ① | AC1 | AC Input |
| ② | ② | AC2 | |
| ③ | ③ | +BC | +BC output |
| ④ | ④ | -BC | -BC output |
| ⑤ | ⑤ | +VOUT | +DC output |
| ⑦ | ⑨ | -VOUT | -DC output |
| - | ⑧ | -S | Remote sensing (-) |
| - | ⑥ | +S | Remote sensing (+) |
| ⑥ | ⑦ | TRM | Adjustment of output voltage |

2. Connection for Standard Use

2.1 Connection for standard use

- To use the TU series, external parts should be connected as shown in Fig. 2.1.
- The TU series should be conduction-cooled. Use a heatsink or fan to dissipate heat.

Fig. 2.1
Connection for
standard use

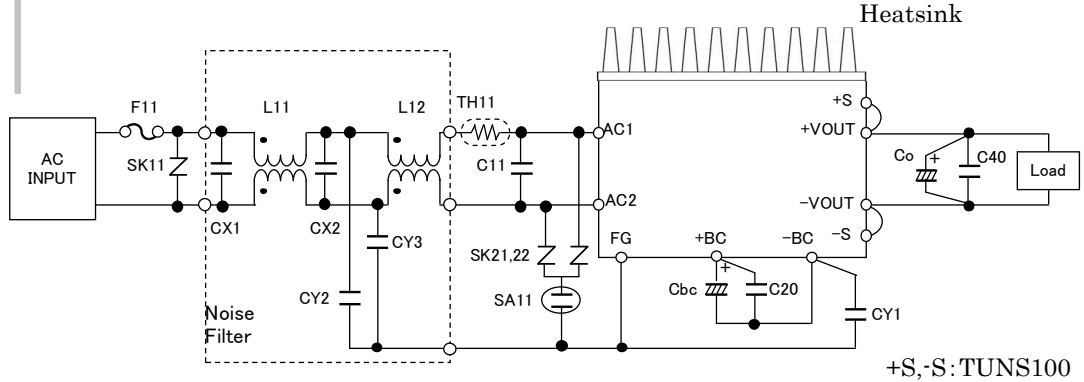

Table 2.1
Parts name

| No. | Symbol | Item | TUNS50 | | TUNS100 | | |
|-----|----------------------|---------------------------------------|---------------|--|--|--|--|
| | | | Rating | Part name | Rating | Part name | |
| 1 | F11 | Input fuse | 250V/2A | SBL20 (Daito Communication Apparatus) | 250V/3.15A | SBL32 (Daito Communication Apparatus) | |
| 2 | C11 | Input capacitor | AC310V/1uF | LE105-MX (OKAYA ELECTRIC INDUSTRIES) | AC310V/1uF | LE105-MX (OKAYA ELECTRIC INDUSTRIES) | |
| 3 | CY1 | Y capacitor | AC250V/2200pF | DE1E3KX222M (Murata Manufacturing) | AC250V/2200pF | DE1E3KX222M (Murata Manufacturing) | |
| 4 | L11 | Line Filter | 9.3mH/1A | SS11VL-R10093 (NEC TOKIN) | 4.3mH/1.7A | SSB11V-R17043 (NEC TOKIN) | |
| 5 | L12 | | 9.3mH/1A | SS11VL-R10093 (NEC TOKIN) | 4.3mH/1.7A | SSB11V-R17043 (NEC TOKIN) | |
| 6 | CX1 | X capacitor | AC310V/0.22uF | LE224-MX (OKAYA ELECTRIC INDUSTRIES) | AC310V/0.68uF | LE684-MX (OKAYA ELECTRIC INDUSTRIES) | |
| 7 | CX2 | | AC310V/0.22uF | LE224-MX (OKAYA ELECTRIC INDUSTRIES) | AC310V/0.68uF | LE684-MX (OKAYA ELECTRIC INDUSTRIES) | |
| 8 | CY2 | Y capacitor | AC250V/2200pF | DE1E3KX222M (Murata Manufacturing) | AC250V/2200pF | DE1E3KX222M (Murata Manufacturing) | |
| 9 | CY3 | | - | - | - | - | |
| 10 | Co | Output capacitor | F05 | DC10V/2200uF | ELXZ100ELL222MK20S (Nippon Chemi-Con) | DC10V/2200uF | ELXZ100ELL222MK20S (Nippon Chemi-Con) |
| | | | F12 | DC25V/470uF | ELXZ250ELL471MJ16S (Nippon Chemi-Con) | DC25V/470uF | ELXZ250ELL471MJ16S (Nippon Chemi-Con) |
| | | | F24 | DC35V/220uF | ELXZ350ELL221MJC5S (Nippon Chemi-Con) | DC35V/220uF | ELXZ350ELL221MJC5S (Nippon Chemi-Con) |
| 11 | C40 | Bypass capacitor | F05 | DC16V/10uF | GRM31CR71C106 (Murata Manufacturing) | DC16V/10uF | GRM31CR71C106 (Murata Manufacturing) |
| | | | F12 | DC50V/4.7uF | GRM31CR71H475 (Murata Manufacturing) | DC50V/4.7uF | GRM31CR71H475 (Murata Manufacturing) |
| 12 | Cbc | Smoothing capacitor for boost voltage | DC420V/82uF | EKXJ421ELL820MLP1S (Nippon Chemi-Con) | DC420V/120uF | EKXJ421ELL121MM40S (Nippon Chemi-Con) | |
| 13 | C20 | Capacitor for boost voltage | DC450V/0.47uF | AFS450V474K (OKAYA ELECTRIC INDUSTRIES) | DC450V/0.47uF | AFS450V474K (OKAYA ELECTRIC INDUSTRIES) | |
| 14 | TH11 | Inrush current limiting resistor | 5Ω | 5D2-08LC (SEMITEC) | 8Ω | 8D2-11LC (SEMITEC) | |
| 15 | SK11 SK21 SK22 | Varistor | 620V | TND14V-621 (Nippon Chemi-Con) | 620V | TND14V-621 (Nippon Chemi-Con) | |
| 16 | SA11 | Surge absorber | 3kV | DSA-302MA (Mitsubishi Materials) | 3kV | DSA-302MA (Mitsubishi Materials) | |

- Parts name are shown in Table 2.1 as reference.
- External parts should be changed according to the ambient temperature, and input and output conditions.
For details, refer to the selection method of individual parts.

2.2 Input fuse: F11

- No protective fuse is preinstalled on the input side. To protect the unit, install a slow-blow type fuse shown in Table 2.2 in the input circuit.

Table 2.2
Recommended
fuse

| Model | TUNS50 | TUNS100 |
|---------------|--------|---------|
| Rated current | 2A | 3.15A |

2.3 Input capacitor: C11

- Connect a film capacitor of 1 μF or higher as input capacitor C11.
- Use a capacitor with a rated voltage of AC250V which complies with the safety standards.
- If C11 is not connected, the power supply or external components may be damaged.
- Ripple current values flowing into C11 as listed in Table 2.1 are shown in Fig. 2.2.
- The frequency of the ripple current is 80 kHz to 600 kHz.
- When selecting a capacitor, check the maximum allowable ripple current.
- The ripple current changes with PCB patterns, external parts, ambient temperature, etc. Check the actual ripple current value flowing through C11.

Fig. 2.2
Ripple current
values
C11

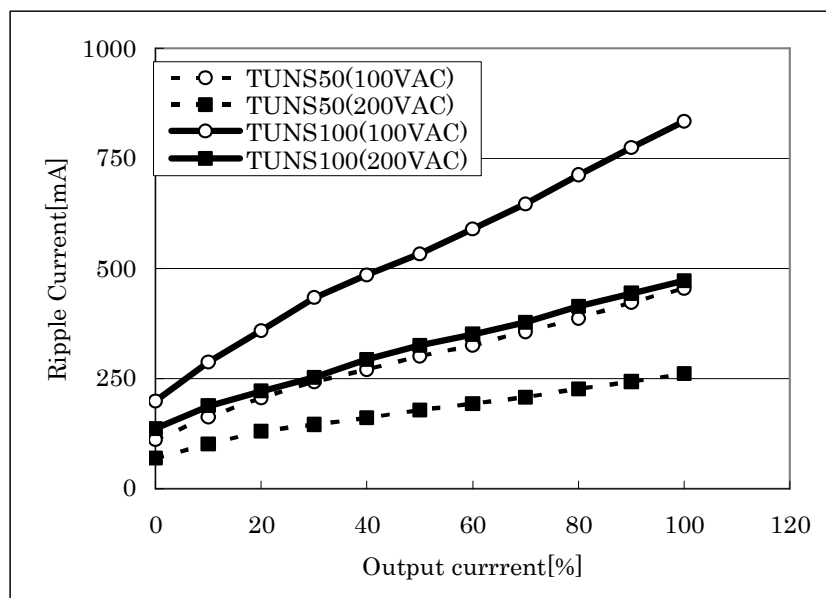

2.4 Y Capacitors and noise filters: CY, CX, L1

- The TU series have no internal noise filter.
Connect external noise filters and capacitors (CY) to reduce conduction noise and stabilize the operation of the power supply.
- Noise filters should be properly designed when the unit must conform to the EMI/EMS standards or when surge voltage may be applied to the unit.
- Install the primary Y capacitor (CY1) as close as possible to the input pins (within 50 mm from the pins).
A capacitance of 470 pF or more is required.
- When the total capacitance of CYs exceeds 8,800 pF, input-output withstanding voltage may be dropped. In this case, either reduce the capacitance of Y capacitors or install a grounding capacitor between output and FG.
- Use capacitors with a rated voltage of AC250V which comply with the safety standards as CY.

2.5 Output capacitors: Co, C40

- Install an external capacitor, Co, between +VOUT and -VOUT pins for stable operation of the power supply. Recommended capacitance of Co is shown in Table 2.3.
- Use low impedance electrolytic capacitors with excellent temperature characteristics.
- When used at ambient temperatures below 0 °C, the output ripple voltage increases due to the characteristics of equivalent series resistance (ESR). In this case, connect three capacitors, Co, of recommended capacitance in parallel connection.
- Specifications, output ripple and ripple noise as evaluation data values are measured according to Fig. 2.3.

Table 2.3
Recommended
capacitance
Co

| Output Voltage | TUNS50 | TUNS100 |
|----------------|---------|---------|
| 5V | 2,200uF | 2,200uF |
| 12V | 470uF | 470uF |
| 24V | 220uF | 220uF |

Fig. 2.3
Measuring
environment

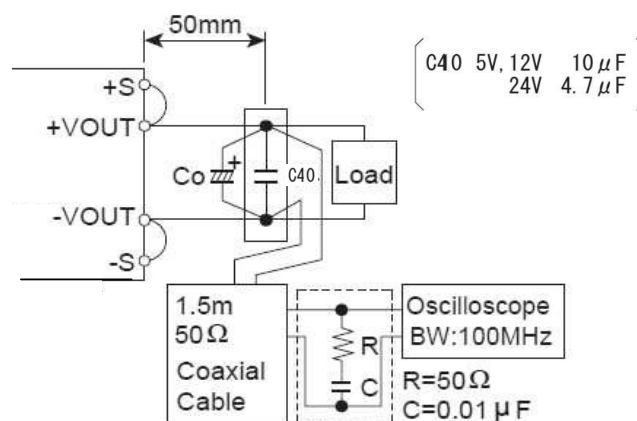

2.6 Smoothing capacitor for boost voltage: Cbc

- To smooth boost voltage, connect Cbc across +BC and -BC.
Recommended capacitance of Cbc is shown in Table 2.4.
- Install a capacitor Cbc whose rated voltage is DC420 V or higher within the allowable capacitance.
- When operated below 0°C, operation may become unstable as boost ripple voltage increases due to ESR characteristics. Choose a capacitor which has higher capacitance than recommended.
Select a capacitor so that the ripple voltage of the boost voltage is 30 Vp-p or below.
- If the ripple voltage of the boost voltage increases, the ripple current rating of the smoothing capacitor may be exceeded. Check the maximum allowable ripple current of the capacitor.
- The ripple current changes with PCB patterns, external parts, ambient temperature, etc. Check the actual ripple current value flowing through Cbc.

Table 2.4
Recommended
capacitance
Cbc

| Model | Recommended capacitance | Allowable capacitance range |
|---------|-------------------------|-----------------------------|
| TUNS50 | 82uF | 47uF ~ 150uF |
| TUNS100 | 120uF | 68uF ~ 220uF |

2.7 Capacitor for boost voltage :C20

- Install a film capacitor with a rating of 0.47uF/DC450V or higher as C20.
- If C20 is not connected, the power supply or external components may be damaged.
- Ripple current values flowing into C20 as listed in Table 2.1 are shown in Fig. 2.4.
- The frequency of the ripple current is 80 kHz to 600 kHz.
- The ripple current flows into this capacitor. Check the maximum allowable ripple current of the capacitor when selecting.
- The ripple current changes with PCB patterns, external parts, ambient temperature, etc. Check the actual ripple current value flowing through C20.

Fig. 2.4
Ripple current
values
C20

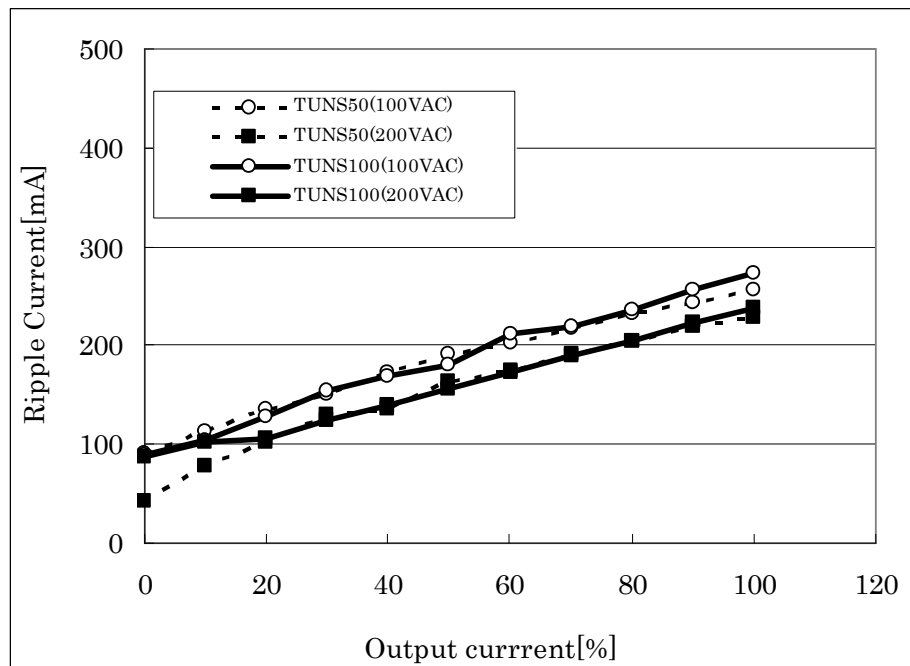

2.8 Inrush current limiting thermistor: TH11

- The TU series have no internal inrush current limiting circuit.
- Inrush current may possibly damage internal components. Provide a power thermistor or inrush current limiting circuit in the input line to keep inrush current below 60A. The characteristics of power thermistor as listed in Table 2.1 are shown in Fig. 2.5.
- When using a power thermistor and turning it ON/OFF repeatedly within a short period of time, keep appropriate intervals to allow the power supply to cool down sufficiently before turning on. Such intervals are also required when an inrush current limiting circuit is used.
- Inrush current values with external parts as listed in Table 2.1 are shown in Fig. 2.6.
- The inrush current changes by PCB pattern, parts characteristic etc.
Check the actual inrush current value flowing through the AC line.

Fig. 2.5
Characteristics of
power thermistor
TH11

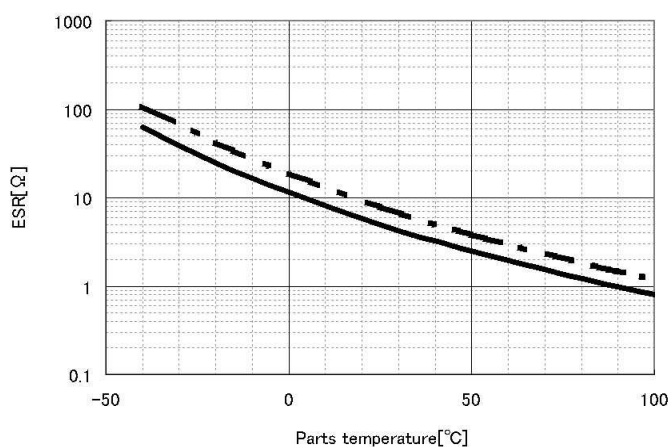
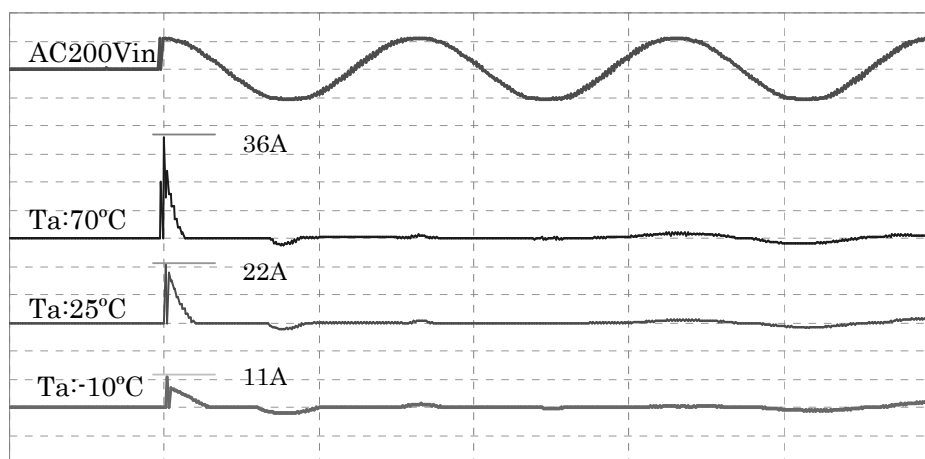

Fig. 2.6
Inrush current
values



TUNS50F24

- Under low temperature conditions, the output of power supply may be unstable due to high ESR values of the power thermistor and Cbc. Check with the actual device before use.
※Refer to page A-8 for operation under low temperature conditions.

3. Derating

3.1 Input voltage derating

- The Input voltage derating curve is shown in Fig. 3.1.

Fig. 3.1
Input voltage
derating

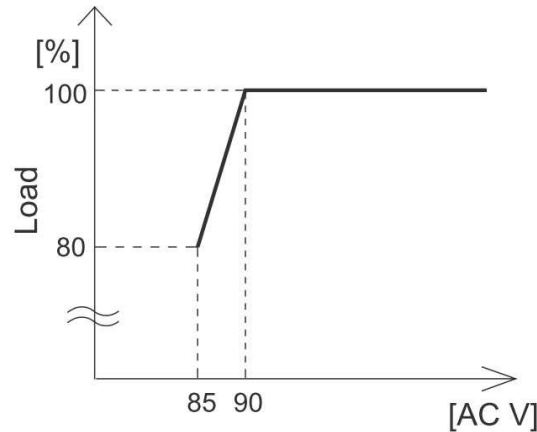

3.2 Output current derating

- The TU series should be conduction-cooled.
- Fig. 3.2 shows the derating curve in relation with the temperature of the aluminum base plate.
Note that operation within the shaded area will cause a significant level of ripple and ripple noise.
- Measure the temperature of the aluminum base plate at the center.
- Attention should be paid to thermal fatigue life due to temperature fluctuations by self-heating. Make the range of temperature fluctuations as narrow as possible if temperature often fluctuates.

Fig. 3.2
Output current
derating

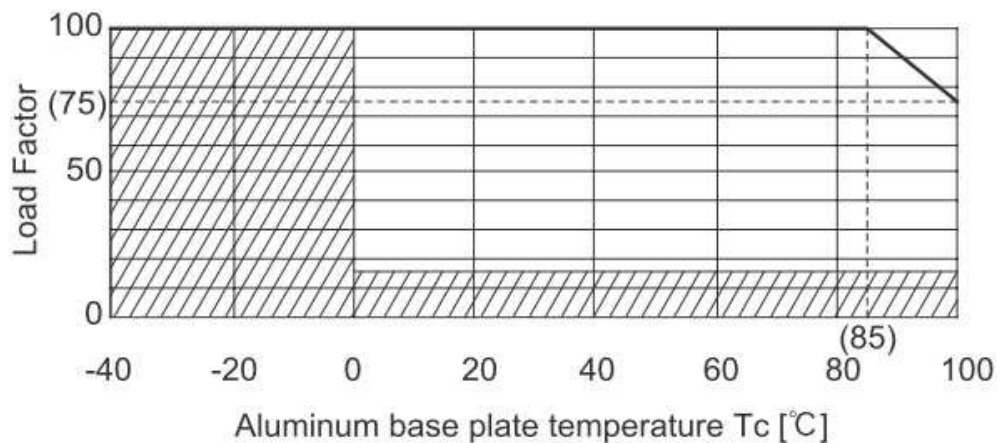

4. Operation Under Low Temperature Conditions

4.1 Outline of low temperature operation

- At low temperatures, output may become unstable immediately after startup or at dynamic load changes due to high ESR values of the power thermistor and Cbc. Check with the actual device before use.
 - Operation becomes stable as the temperature of the power thermistor rises.
 - To prevent such unstable operation, choose a low ESR capacitor as Cbc, that has sufficient capacitance within the allowable range and excellent temperature characteristics.
- <Notes for operation at ambient temperatures between -10°C and -40°C>
- * Avoid the gradual increase of input voltage and forced air cooling.
 - * Output voltage may remain unstable at low load current. In this case, use the minimum load current.
 - * One minute after startup, the characteristics of TH11 and Cbc become stable, which then stabilizes output.
- Fig. 4.1 shows stable operation at 25°C and unstable operation at -40°C after startup and at dynamic load changes.

Fig.4.1
Difference of
operation with
temperature

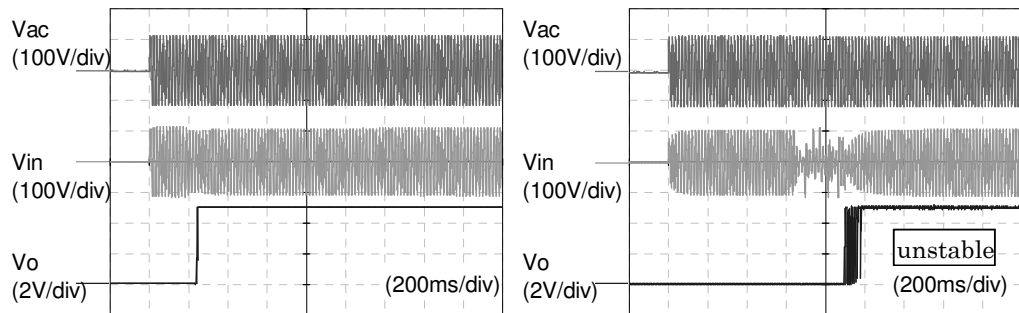

Startup (TUNS100)

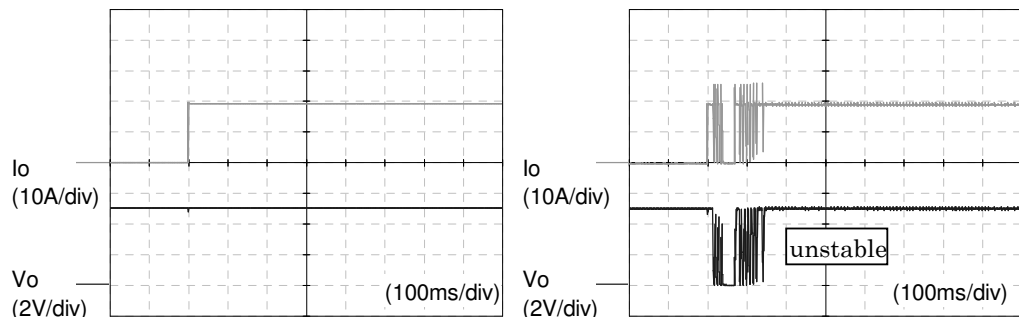

Load 0% to 100%(TUNS100)

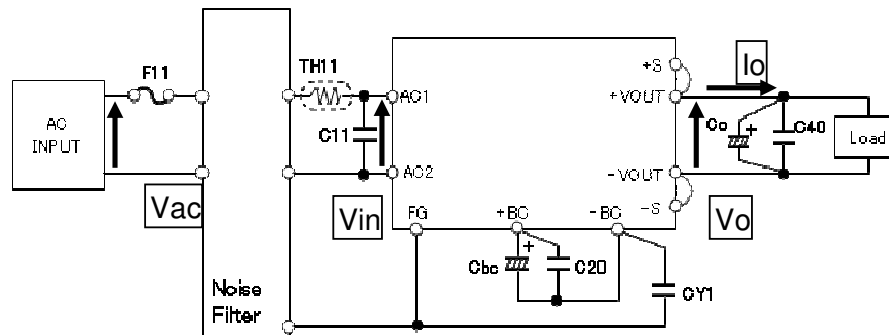

4.2 Improvement of unstable operation

- Unstable operation can be improved by increasing the capacitance of Cbc.
At low temperatures, increase the capacitance of Cbc within the range of recommended values.
- Fig. 4.2 shows the boundary line examples of stable and unstable operation.

Fig. 4.2
Boundary line
of stable and
unstable operation

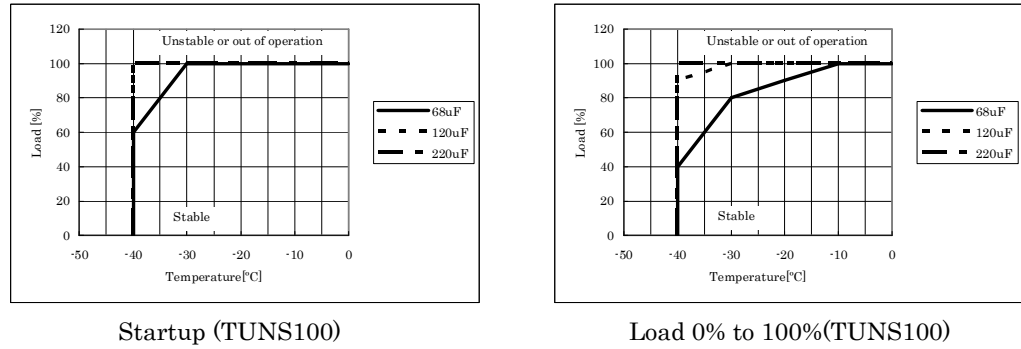

4.3 Relationship between unstable operation and input voltage

- When the input voltage is low, the area for unstable operation is extended.
- Fig. 4.3 shows differences in operation with input voltage.

Fig. 4.3
Difference in
operation with
Vin

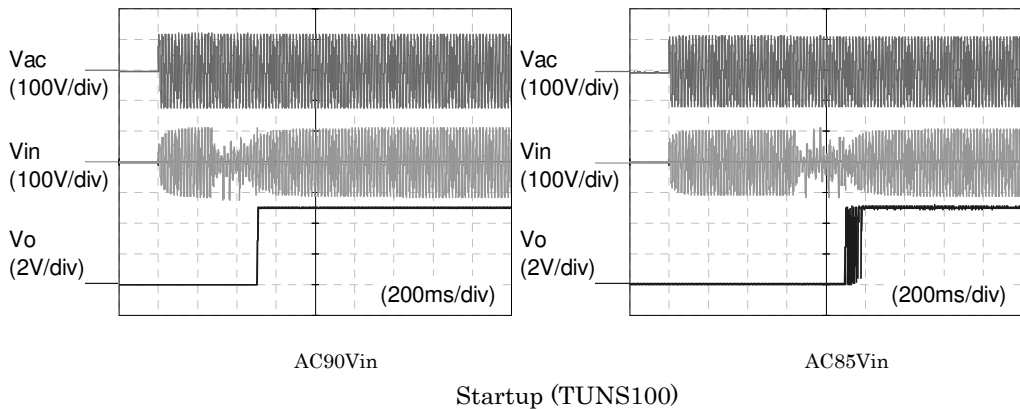

- Page A-11 shows boundary line examples between stable and unstable operation.
(Data were obtained from circuit connection shown in Fig. 2.1 with external parts shown in Table 2.1.)

5. Holdup Time

■ Holdup time is determined by the capacitance of Cbc. Fig. 5.1 shows the relationship between holdup time and load within the allowable capacitance of Cbc.

Fig. 5.1
Relationship
between
holdup time
and Cbc

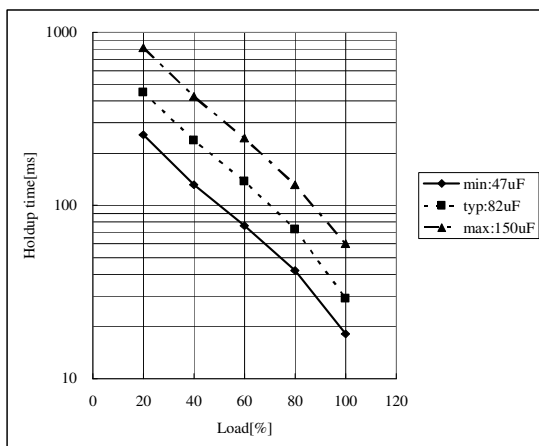

TUNS50

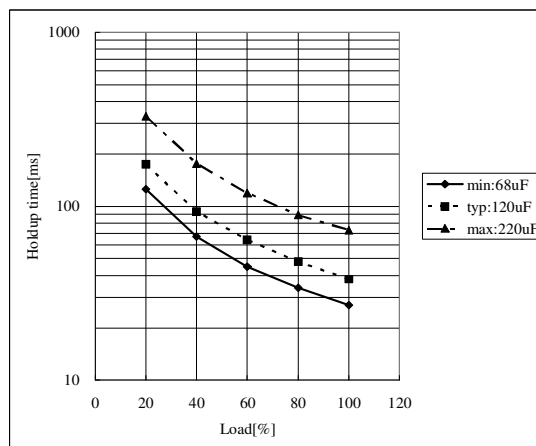

TUNS100

Appendix

Fig. A
Boundary line
examples between
unstable and
stable operation

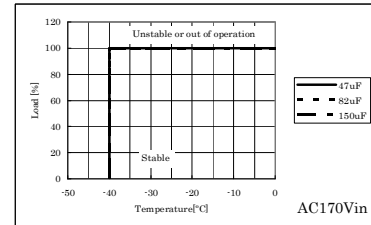
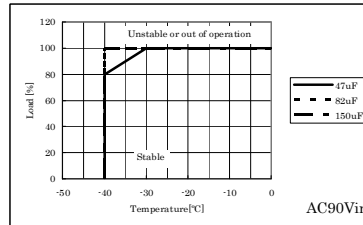
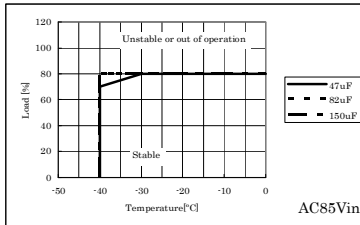

Boundary line of stable operation at startup (TUNS50)

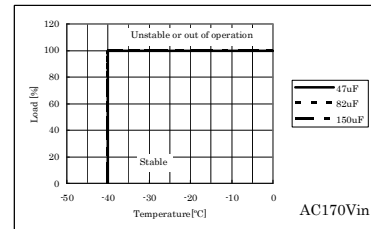
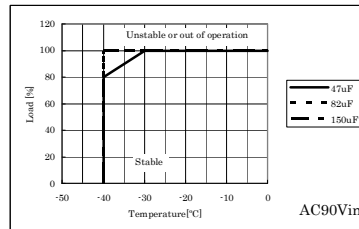
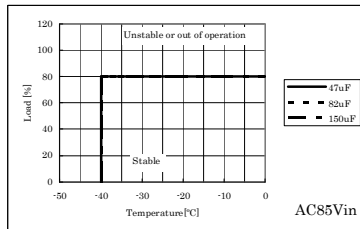

Boundary line of stable operation at dynamic load change from 0% to 100% (TUNS50)

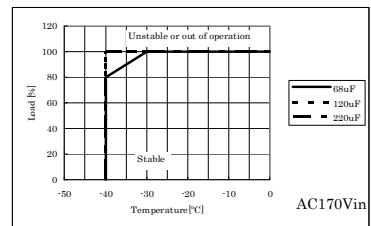
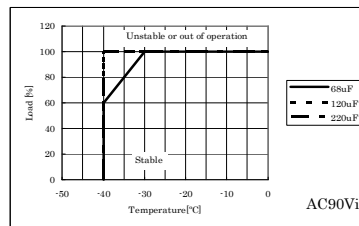
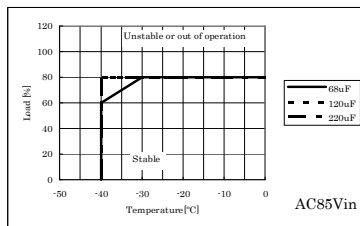

Boundary line of stable operation at startup (TUNS100)

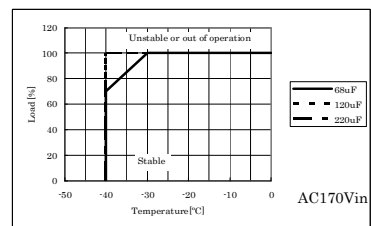
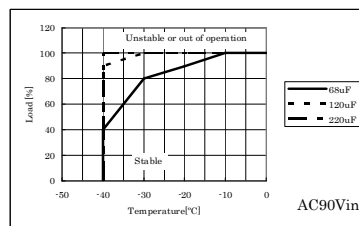
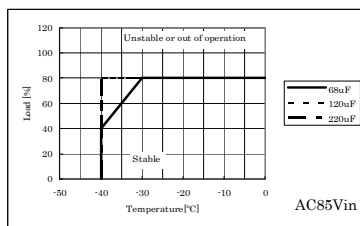

Boundary line of stable operation at dynamic load change from 0% to 100% (TUNS100)

FORTEC

ELEKTRONIK AG

Our company network supports you worldwide with offices in Germany, Austria, Switzerland, Great Britain and the USA. For more information please contact:

FORTEC Elektronik AG

Hauptniederlassung
Lechwiesenstr. 9
86899 Landsberg am Lech

Telefon: +49 (0) 8191 91172-0
Telefax: +49 (0) 8191 21770
E-Mail: sales@fortecag.de
Internet: www.fortecag.de

FORTEC Elektronik AG

Büro Nord
Am Hasenkamp 36
22457 Hamburg

Telefon: +49 (0) 40 54 80 56 11
Telefax: +49 (0) 40 54 80 56 13
E-Mail: nord@fortecag.de
Internet: www.fortecag.de

FORTEC Elektronik AG

Büro West
Hohenstaufenring 55
50674 Köln

Telefon: +49 (0) 221 272 273-0
Telefax: +49 (0) 221 272 273-10
E-Mail: west@fortecag.de
Internet: www.fortecag.de

FORTEC Elektronik AG

Büro Wien
Nuschinggasse 12
A-1230 Wien

Telefon: +43 1 8673492-0
Telefax: +43 1 8673492-26
E-Mail: office@fortec.at
Internet: www.fortec.at

ALTRAC AG

(Tochter der Fortec AG):
Bahnhofstraße 3
CH-5436 Würenlos

Telefon: +41 (0) 44 7446111
Telefax: +41 (0) 44 7446161
E-Mail: info@altrac.ch
Internet: www.altrac.ch

Members of the FORTEC Group:

