

Instruction Manual

KL-Series

Cosel

Our company network supports you worldwide with offices in Germany, Austria, Switzerland, Great Britain and the USA. For more information please contact:

FORTEC Elektronik AG

Hauptniederlassung
Lechwiesenstr. 9
86899 Landsberg am Lech

Telefon: +49 (0) 8191 91172-0

Telefax: +49 (0) 8191 21770

E-Mail: sales@fortecag.de

Internet: www.fortecag.de

FORTEC Elektronik AG

Büro Nord
Am Hasenkamp 36
22457 Hamburg

Telefon: +49 (0) 40 54 80 56 11

Telefax: +49 (0) 40 54 80 56 13

E-Mail: nord@fortecag.de

Internet: www.fortecag.de

FORTEC Elektronik AG

Büro West
Hohenstaufenring 55
50674 Köln

Telefon: +49 (0) 221 272 273-0

Telefax: +49 (0) 221 272 273-10

E-Mail: west@fortecag.de

Internet: www.fortecag.de

FORTEC Elektronik AG

Büro Wien
Nuschinggasse 12
A-1230 Wien

Telefon: +43 1 8673492-0

Telefax: +43 1 8673492-26

E-Mail: office@fortec.at

Internet: www.fortec.at

ALTRAC AG

(Tochter der FORTEC):
Bahnhofstraße 3
CH-5436 Würenlos

Telefon: +41 (0) 44 7446111

Telefax: +41 (0) 44 7446161

E-Mail: info@altrac.ch

Internet: www.altrac.ch

The information contained in this document has been carefully researched and is, to the best of our knowledge, accurate. However, we assume no liability for any product failures or damages, immediate or consequential, resulting from the use of the information provided herein. Our products are not intended for use in systems in which failures of product could result in personal injury. All trademarks mentioned herein are property of their respective owners. All specifications are subject to change without notice.

Basic Characteristics Data

Model	Circuit method	Switching frequency [KLz]	Input current [A] *1	Rated input fuse	Inrush current protection circuit	PCB/Pattern			Series/Parallel operation availability	
						Material	Single sided	Double sided	Series operation	Parallel operation
KLEA120F	Active filter	40 - 160	1.2	250V 4A	Thermistor	FR-4		Yes	Yes	No
KLNA120F	Flyback converter	20 - 150*2								
KLEA240F	Active filter	50 - 70	2.4	250V 8A	Thermistor	FR-4		Yes	Yes	No
KLNA240F	Forward converter	130								

*1 The value of input current is at ACIN 115V and 100%.

*2 Burst operation at light loading, frequency is change by use condition.
Please contact us about detail.

1 Terminal Blocks KL-8

2 Functions KL-9

2.1	Input Voltage Range	KL-9
2.2	Inrush Current Limiting	KL-9
2.3	Overcurrent Protection	KL-9
2.4	Overvoltage Protection	KL-9
2.5	Output Ripple and Ripple Noise	KL-9
2.6	Output Voltage Adjustment Range	KL-9
2.7	Isolation	KL-9
2.8	Signal Output	KL-9

3 Series/Parallel Operation KL-10

3.1	Series Operation	KL-10
3.2	Parallel Operation	KL-10

4 Assembling and Installation Method KL-10

4.1	Installation Mounting methods	KL-10
4.2	Derating curve depend on input voltage	KL-11
4.3	Derating curve depend on ambient temperature	KL-11
4.4	Expected Life and Warranty	KL-12
4.5	Applicable Electric Cable	KL-13
4.6	Others	KL-13

5 Option KL-13

5.1	Outline of option	KL-13
-----	-------------------------	-------

1 Terminal Blocks

● KLEA120F

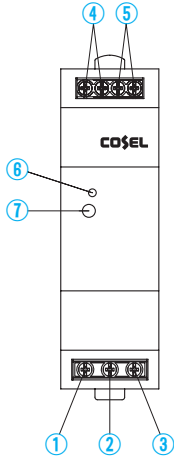

● KLNA120F

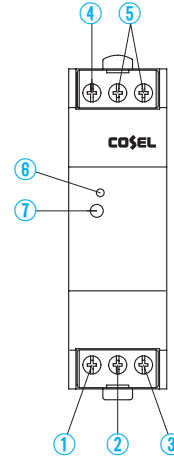

● KLEA240F

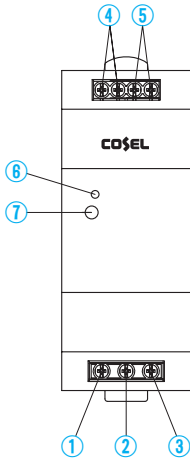

● KLNA240F

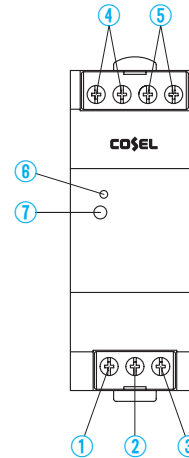

Terminal Number	Terminal Name	Function
①	PE	Protective earth Terminal
②	AC (N)	Input Terminals
③	AC (L)	
④	+VOUT	+Output Terminals
⑤	-VOUT	-Output Terminals
⑥	DC_OK	LED for output voltage confirmation
⑦	TRM	Adjustment of output voltage

2 Functions

2.1 Input Voltage Range

- Input voltage range of the power supplies is from AC85V to AC264V.
- To comply with safety standards, input voltage range is AC100-AC240V (50/60Hz).
- If input value doesn't fall within above range, a unit may not operate in accordance with specifications and/or start hunting or operate protection circuit or fail.
If you need to apply a square waveform input voltage, which is commonly used in UPS and inverters, please contact us.
- When the input voltage changes suddenly, the output voltage accuracy might exceed the specification. Please contact us.
- When the power supply is used with DC voltage input, an external DC fuse is required for protection. Consult us for more details.
- If the input voltage is more than AC250V, power factor correction does not work and the power factor deteriorates. Consult us for more details. (except KLEA240F, KLNA240F)
- Operation stop voltage is set at a lower value than of a standard version (derating is needed).
 - Use Conditions

	Output
KLEA120F, KLNA120F	70W
KLEA240F, KLNA240F	100W
Input AC50V or DC70V	
Duty 1s/30s	

*Please avoid using continuously for more than 1 second under above conditions. Doing so may cause a failure.

2.2 Inrush Current Limiting

- An inrush current limiting circuit is built-in.
- If you need to use a switch on the input side, please select one that can withstand an input inrush current.
- Thermistor is used in the inrush current limiting circuit. When you turn the power ON/OFF repeatedly within a short period of time, please have enough intervals so that a power supply cools down before being turned on.

2.3 Overcurrent Protection

- An overcurrent protection circuit is built-in and activated at 105% of the rated current. A unit automatically recovers when a fault condition is removed. Please do not use a unit in short circuit and/or under an overcurrent condition.
- Intermittent Operation Mode (except KLEA240F, KLNA240F)
When the overcurrent protection circuit is activated and the output voltage drops to a certain extent, the output becomes intermittent so that the average current will also decrease.

2.4 Overvoltage Protection

- An overvoltage protection circuit is built-in. If the overvoltage protection circuit is activated, shut down the input voltage, wait more than 3 minutes and turn on the AC input again to recover the output voltage. Recovery time varies depending on such factors as input voltage value at the time of the operation.

Note :

Please avoid applying a voltage exceeding the rated voltage to an output terminal. Doing so may cause a power supply to malfunction or fail. If you cannot avoid doing so, for example, if you need to operate a motor, etc., please install an external diode on the output terminal to protect the unit.

2.5 Output ripple and ripple noise

- Output ripple noise may be influenced by measurement environment, measuring method fig 2.1 is recommended.

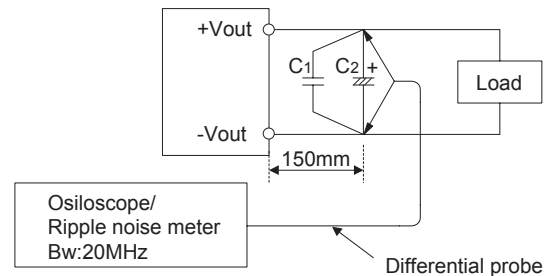

C1: Film capacitor 0.1 μF
C2: Aluminum electrolytic capacitor 22 μF

Fig.2.1 Measuring method of Ripple and Ripple Noise

2.6 Output Voltage Adjustment Range

- To increase an output voltage, turn a built-in potentiometer clockwise. To decrease the output voltage, turn it counterclockwise.

2.7 Isolation

- When you run a Hi-Pot test as receiving inspection, gradually increase the voltage to start. When you shut down, decrease the voltage gradually by using a dial. Please avoid a Hi-Pot tester with a timer because, when the timer is turned ON or OFF, it may generate a voltage a few times higher than the applied voltage.

2.8 Signal Output

Functions of LED indicators.

- Functions of LED indicators and signal output in the form of are shown below. Checking the presence/absence of voltage at the output terminal of a power supply is possible.

Table 2.1 Description of the signal output

Signal Output	Normal	Output is decreasing
DC_OK (LED: Green)	ON	OFF

3 Series/Parallel Operation

3.1 Series Operation

■ You can use a power supply in series operation. The output current in series operation should be lower than the rated current of a power supply with the lowest rated current among the power supplies that are serially connected. Please make sure that no current exceeding the rated current flows into a power supply.

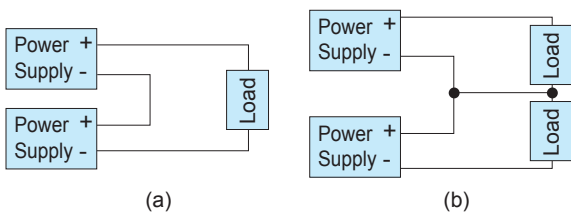

Fig.3.1 Examples of connecting in series operation

3.2 Parallel Operation

■ There is no current balance function. When operating in parallel, such as diode-OR, please use on the output voltage was adjusted enough to balance the current. Exceeds the rated output current, the output is shut down.

■ Redundancy operation is available by wiring as shown below.

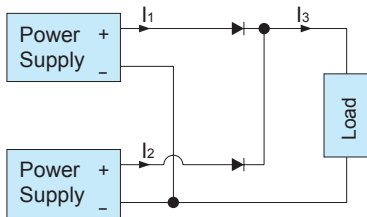

Fig.3.2 Example of connecting in redundancy operation

Even a slight difference in output voltage can affect the balance between the values of I_1 and I_2 . Please make sure that the value of I_3 does not exceed the rated current of a power supply.

$$I_3 \leq \text{rated current value}$$

4 Assembling and Installation Method

4.1 Installation Mounting methods

■ About DIN-Rail

Use top hat rail TH 35-7.5 of 35mm according to EN60715.

■ Below shows mounting orientation.

If install other than standard mounting orientation (A), please fix the power supply for withstand the impact and vibration.

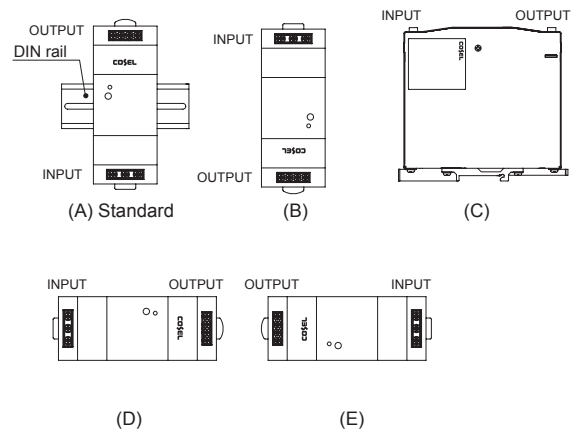

Fig.4.1 Mounting orientation

■ When you mount a power supply on a DIN rail, have the area marked A catch one side of the rail and push the unit to the direction of B. To remove the power supply from the rail, either push down the area marked C or insert a tool such as driver to the area marked D and pull the unit apart from the rail. When you couldn't remove the unit easily, push down the area marked C while lightly pushing the unit to the direction of E.

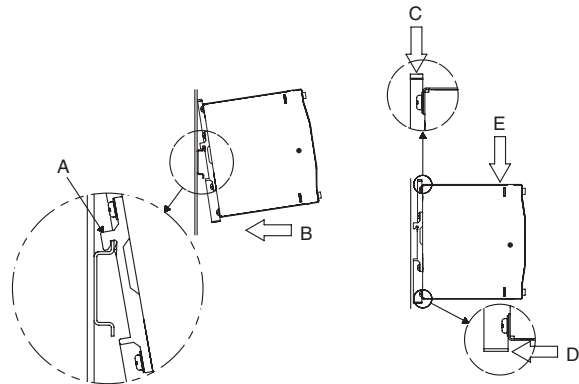

Fig.4.2 Installation method

■Shown below the notes about installation clearance of a unit.

① Installation clearance at above and below the unit.

Please have clearance of at least 25mm above and below the unit to avoid heat accumulation.

② Installation clearance at the side of the unit.

Please have clearance of at least 15mm side the unit to avoid interfering with heat radiation from housing. However, refer to Table 4.1, if adjacent device of the unit (including power supply) is a heat source.

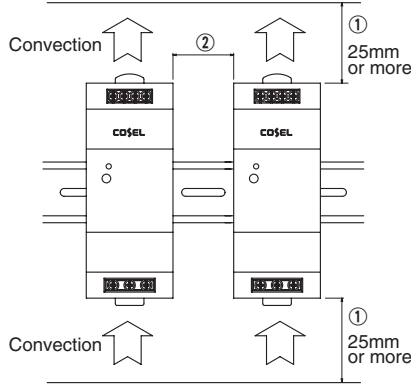

Fig.4.3 Installation clearance

Table 4.1 Installation clearance at the side of the unit.

No.	Model	Adjacent device of the unit	
		Non-heat source	Heat source(*)
1	KLEA120F, KLNA120F	15mm or more	25mm or more
2	KLEA240F, KLNA240F	15mm or more	25mm or more

*Reference value when same power units are adjacent.

4.2 Derating curve depend on input voltage

■Derating curve depend on input voltage.

Derating curve depend on input voltage is shown in Fig.4.4.

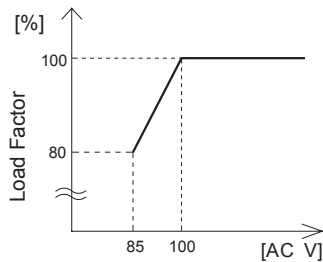

Fig.4.4 Derating curve depend on input voltage

4.3 Derating curve depend on ambient temperature

■The operative ambient temperature as different by input voltage.

Derating curve is shown below.

■In the hatched area,the specification of Ripple,Ripple Noise is different from other area.

■Derating Curve (Convection)

● KLEA120F, KLNA120F

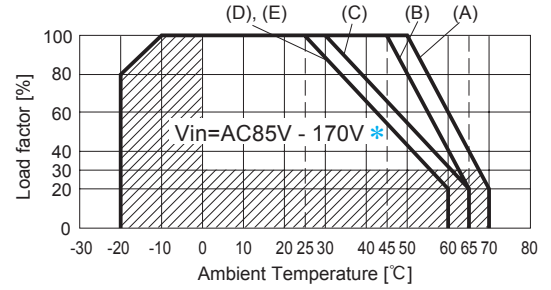

* Derating curve depend on input voltage is required.

Fig.4.5 Derating curve depend on ambient temperature

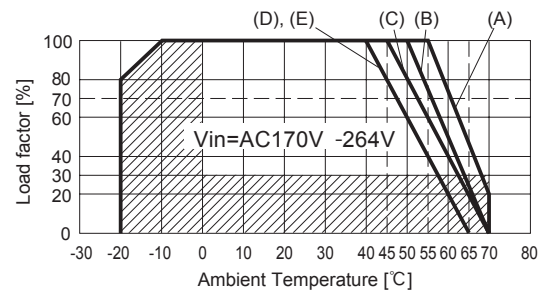
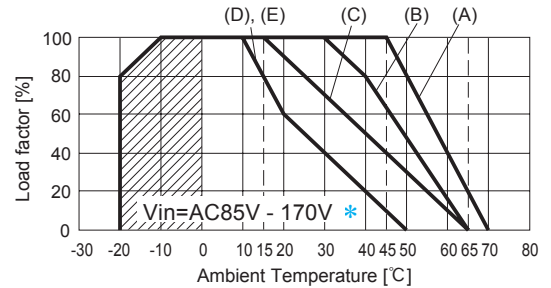

Fig.4.6 Derating curve depend on ambient temperature

● KLEA240F, KLNA240F



* Derating curve depend on input voltage is required.

Fig.4.7 Derating curve depend on ambient temperature

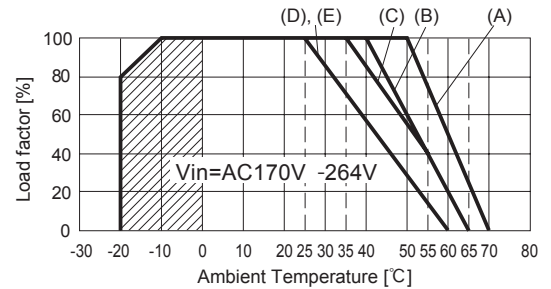

Fig.4.8 Derating curve depend on ambient temperature

■ Ambient temperature indicates the temperature of the inlet of the air.

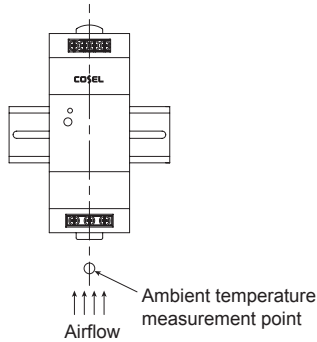

Fig.4.9 Ambient temperature measurement point

● KLEA120F, KLNA120F

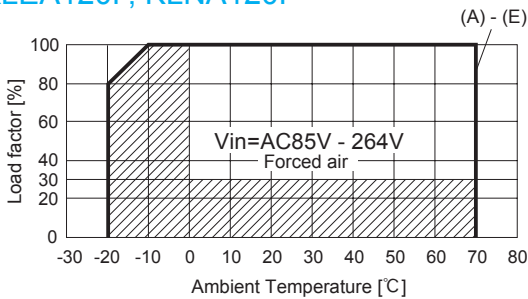

Fig.4.10 Derating curve depend on ambient temperature

● KLEA240F, KLNA240F

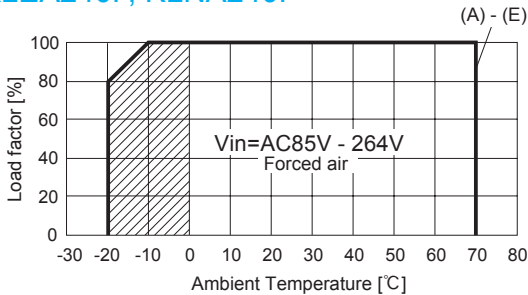

Fig.4.11 Derating curve depend on ambient temperature

■ Temperature of Forced air

Use the temperature measurement point as shown in Fig 4.12. Please use at the temperature does not exceed the values in Table 4.2. Please also make sure that the ambient temperature does not exceed 70°C.

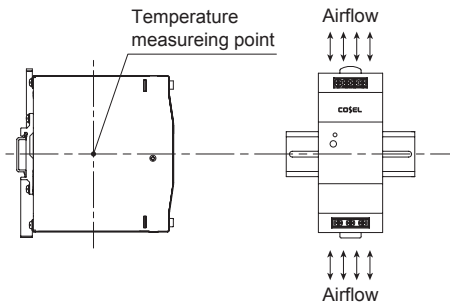

Fig.4.12 Temperature measurement point (Forced air)

Table 4.2 Specified temperature of the measurement point

No.	Model	temperature measurement point
1	KLEA120F, KLNA120F	75°C
2	KLEA240F, KLNA240F	75°C

4.4 Expectancy life and warranty

Please note derating curve depend on input voltage is required.

■ Expectancy Life.

Table 4.3 Expectancy Life (KLEA120F, KLNA120F)

Mounting method	Cooling method	Input voltage	Average ambient temperature (year)	Expectancy Life	
				Load factor $Io \leq 75\%$	Load factor $75\% < Io \leq 100\%$
A	Convection	AC85 - 170V	Ta = 40°C or less	10years	6years
			Ta = 50°C	5years	3years
		AC170 - 264V	Ta = 45°C or less	9years	6years
			Ta = 55°C	4years	3years
B	Convection	AC85 - 170V	Ta = 35°C or less	10years	7years
			Ta = 45°C	5years	3years
		AC170 - 264V	Ta = 40°C or less	10years	8years
			Ta = 50°C	5years	4years
C	Convection	AC85 - 170V	Ta = 20°C or less	10years	10years
			Ta = 30°C	10years	7years
		AC170 - 264V	Ta = 35°C or less	10years	7years
			Ta = 45°C	6years	4years
D and E	Convection	AC85 - 170V	Ta = 15°C or less	10years	6years
			Ta = 25°C	7years	3years
		AC170 - 264V	Ta = 30°C or less	10years	5years
			Ta = 40°C	5years	2years
A,B,C,D and E	Forced air	AC85 - 264V	Ta = 70°C	5years	3years

Table 4.4 Expectancy Life (KLEA240F, KLNA240F)

Mounting method	Cooling method	Input voltage	Average ambient temperature (year)	Expectancy Life	
				Load factor $Io \leq 75\%$	Load factor $75\% < Io \leq 100\%$
A	Convection	AC85 - 170V	Ta = 35°C or less	8years	5years
			Ta = 45°C	4years	2years
		AC170 - 264V	Ta = 40°C or less	8years	6years
			Ta = 50°C	4years	3years
B	Convection	AC85 - 170V	Ta = 20°C or less	10years	5years
			Ta = 30°C	5years	2years
		AC170 - 264V	Ta = 30°C or less	8years	5years
			Ta = 40°C	4years	2years
C	Convection	AC85 - 170V	Ta = 5°C or less	10years	10years
			Ta = 15°C	10years	6years
		AC170 - 264V	Ta = 25°C or less	10years	7years
			Ta = 35°C	5years	3years
D and E	Convection	AC85 - 170V	Ta = 0°C or less	10years	5years
			Ta = 10°C	5years	2years
		AC170 - 264V	Ta = 15°C or less	9years	5years
			Ta = 25°C	4years	2years
A,B,C,D and E	Forced air	AC85 - 264V	Ta = 70°C	5years	3years

■Warranty

Table 4.5 Warranty (KLEA120F, KLNA120F)

Mounting method	Cooling method	Input voltage	Average ambient temperature (year)	Warranty term	
				Load factor $Io \leq 75\%$	Load factor $75% < Io \leq 100\%$
A	Convection	AC85 - 170V	Ta = 40°C or less	5years	5years
			Ta = 50°C	5years	3years
		AC170 - 264V	Ta = 45°C or less	5years	5years
			Ta = 55°C	4years	3years
B	Convection	AC85 - 170V	Ta = 35°C or less	5years	5years
			Ta = 45°C	5years	3years
		AC170 - 264V	Ta = 40°C or less	5years	5years
			Ta = 50°C	5years	4years
C	Convection	AC85 - 170V	Ta = 20°C or less	5years	5years
			Ta = 30°C	5years	5years
		AC170 - 264V	Ta = 35°C or less	5years	5years
			Ta = 45°C	5years	4years
D and E	Convection	AC85 - 170V	Ta = 15°C or less	5years	5years
			Ta = 25°C	5years	3years
		AC170 - 264V	Ta = 30°C or less	5years	5years
			Ta = 40°C	5years	2years
A,B,C,D and E	Forced air	AC85 - 264V	Ta = 70°C	5years	3years

Table 4.6 Warranty (KLEA240F, KLNA240F)

Mounting method	Cooling method	Input voltage	Average ambient temperature (year)	Warranty term	
				Load factor $Io \leq 75\%$	Load factor $75% < Io \leq 100\%$
A	Convection	AC85 - 170V	Ta = 35°C or less	5years	5years
			Ta = 45°C	4years	2years
		AC170 - 264V	Ta = 40°C or less	5years	5years
			Ta = 50°C	4years	3years
B	Convection	AC85 - 170V	Ta = 20°C or less	5years	5years
			Ta = 30°C	5years	2years
		AC170 - 264V	Ta = 30°C or less	5years	5years
			Ta = 40°C	4years	2years
C	Convection	AC85 - 170V	Ta = 5°C or less	5years	5years
			Ta = 15°C	5years	5years
		AC170 - 264V	Ta = 25°C or less	5years	5years
			Ta = 35°C	5years	3years
D and E	Convection	AC85 - 170V	Ta = 0°C or less	5years	5years
			Ta = 10°C	5years	2years
		AC170 - 264V	Ta = 15°C or less	5years	5years
			Ta = 25°C	4years	2years
A,B,C,D and E	Forced air	AC85 - 264V	Ta = 70°C	5years	3years

4.5 Applicable Electric Cable

■Input terminals, Output terminals

Table 4.7 Applicable Wire

	Input terminals	Output terminals
Solid wire	Diameter 0.5 mm to 2.6 mm (AWG.24 to AWG.10)	
Stranded wire	0.2mm ² to 5.2mm ² (AWG.24 to AWG.10) Conductor diameter more than 0.18mm	
Sheath strip length	8mm	

4.6 Applicable Electric Cable

■While turning on the electricity, and for a while after turning off, please don't touch the inside of a power supply because there are some hot parts in that.

■When a mass capacitor is connected with the output terminal (load side), the output might become the stop or an unstable operation. Please contact us for details when you connect the capacitor.

5 Option

5.1 Outline of option

- -C
 - Option -C units have coated internal PCB for better moisture resistance.
- -N2
 - Option -N2 units have attachment with screw mounting instead of DIN rail mounting.
Mounting holes pitch are shown in Table 5.1.

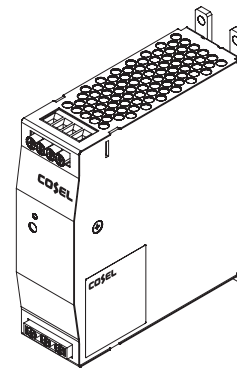

Fig.5.1 Image of option -N2

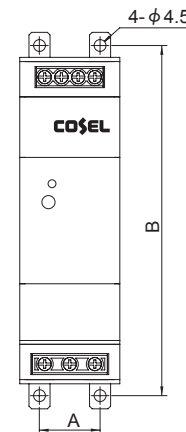

Fig.5.2 Mounting place (screw holes)

Table 5.1 Mounting holes pitch

No.	Model	A	B
1	KLEA120F, KLNA120F	24mm	133mm
2	KLEA240F, KLNA240F	34mm	133mm

FORTEC

ELEKTRONIK AG

Our company network supports you worldwide with offices in Germany, Austria, Switzerland, Great Britain and the USA. For more information please contact:

FORTEC Elektronik AG

Hauptniederlassung
Lechwiesenstr. 9
86899 Landsberg am Lech

Telefon: +49 (0) 8191 91172-0
Telefax: +49 (0) 8191 21770
E-Mail: sales@fortecag.de
Internet: www.fortecag.de

FORTEC Elektronik AG

Büro Nord
Am Hasenkamp 36
22457 Hamburg

Telefon: +49 (0) 40 54 80 56 11
Telefax: +49 (0) 40 54 80 56 13
E-Mail: nord@fortecag.de
Internet: www.fortecag.de

FORTEC Elektronik AG

Büro West
Hohenstaufenring 55
50674 Köln

Telefon: +49 (0) 221 272 273-0
Telefax: +49 (0) 221 272 273-10
E-Mail: west@fortecag.de
Internet: www.fortecag.de

FORTEC Elektronik AG

Büro Wien
Nuschinggasse 12
A-1230 Wien

Telefon: +43 1 8673492-0
Telefax: +43 1 8673492-26
E-Mail: office@fortec.at
Internet: www.fortec.at

ALTRAC AG

(Tochter der Fortec AG):
Bahnhofstraße 3
CH-5436 Würenlos

Telefon: +41 (0) 44 7446111
Telefax: +41 (0) 44 7446161
E-Mail: info@altrac.ch
Internet: www.altrac.ch

Members of the FORTEC Group:

