

Instruction Manual

PLA-Series

Cosel

Our company network supports you worldwide with offices in Germany, Austria, Switzerland, Great Britain and the USA. For more information please contact:

FORTEC Elektronik AG

Hauptniederlassung
Lechwiesenstr. 9
86899 Landsberg am Lech

Telefon: +49 (0) 8191 91172-0

Telefax: +49 (0) 8191 21770

E-Mail: sales@fortecag.de

Internet: www.fortecag.de

FORTEC Elektronik AG

Büro Nord
Am Hasenkamp 36
22457 Hamburg

Telefon: +49 (0) 40 54 80 56 11

Telefax: +49 (0) 40 54 80 56 13

E-Mail: nord@fortecag.de

Internet: www.fortecag.de

FORTEC Elektronik AG

Büro West
Hohenstaufenring 55
50674 Köln

Telefon: +49 (0) 221 272 273-0

Telefax: +49 (0) 221 272 273-10

E-Mail: west@fortecag.de

Internet: www.fortecag.de

FORTEC Elektronik AG

Büro Wien
Nuschinggasse 12
A-1230 Wien

Telefon: +43 1 8673492-0

Telefax: +43 1 8673492-26

E-Mail: office@fortec.at

Internet: www.fortec.at

ALTRAC AG

(Tochter der FORTEC):
Bahnhofstraße 3
CH-5436 Würenlos

Telefon: +41 (0) 44 7446111

Telefax: +41 (0) 44 7446161

E-Mail: info@altrac.ch

Internet: www.altrac.ch

The information contained in this document has been carefully researched and is, to the best of our knowledge, accurate. However, we assume no liability for any product failures or damages, immediate or consequential, resulting from the use of the information provided herein. Our products are not intended for use in systems in which failures of product could result in personal injury. All trademarks mentioned herein are property of their respective owners. All specifications are subject to change without notice.

Basic Characteristics Data

Model	Circuit method	Switching frequency [kHz]	Input current [A]	Rated input fuse	Inrush current protection circuit	PCB/Pattern			Series/Parallel operation availability	
						Material	Single sided	Double sided	Series operation	Parallel operation
PLA15F	Flyback converter	100	0.4 *1	250V 2.5A	Thermistor	CEM-3	Yes		Yes	No
PLA30F	Flyback converter	130	0.7 *1	250V 3.15A	Thermistor	CEM-3	Yes		Yes	No
PLA50F	Active filter	60 to 440	0.7 *1	250V 2.5A	Thermistor	CEM-3	Yes		Yes	No
	Flyback converter	130								
PLA100F	Active filter	40 to 160	1.2 *2	250V 3.15A	Thermistor	CEM-3	Yes		Yes	No
	Flyback converter	20 to 150 *3								
PLA150F	Active filter	40 to 160	1.7 *2	250V 4A	Thermistor	CEM-3	Yes		Yes	No
	Flyback converter	20 to 150 *3								
PLA300F	Active filter	60	3.4 *2	250V 10A	Thermistor	CEM-3	Yes		Yes	No
	Forward converter	140								
PLA600F	Active filter	60	6.7 *2	250V 16A	SCR	FR-4		Yes	Yes	*4
	Forward converter	220								

*1 The input current shown is at ACIN 100V and 100% load.

*2 The input current shown is at ACIN 100V and 90% load.

*3 The burst mode frequency varies according to the operating conditions. Consult us for more details.

*4 Parallel operation is possible with the -W option. See "5. Options and Others" in Instruction Manual.

1	Function	PLA-18
1.1	Input Voltage Range	PLA-18
1.2	Inrush Current Limiting	PLA-18
1.3	Overcurrent Protection	PLA-18
1.4	Overvoltage Protection	PLA-18
1.5	Thermal Protection	PLA-19
1.6	Output Ripple and Ripple Noise	PLA-19
1.7	Output Voltage Adjustment	PLA-19
1.8	Isolation	PLA-19
1.9	Low Power Consumption	PLA-19
1.10	Remote ON/OFF	PLA-19
1.11	Remote Sensing	PLA-19
1.12	LV Alarm	PLA-19
2	Series Operation and Parallel Operation	PLA-20
2.1	Series Operation	PLA-20
2.2	Parallel Operation	PLA-20
3	Assembling and Installation Method	PLA-20
3.1	Installation Method	PLA-20
3.2	Derating	PLA-21
3.3	Expected Life and Warranty	PLA-23
4	Ground	PLA-24
5	Options and Others	PLA-24
5.1	Outline of Options	PLA-24
5.2	Others	PLA-29

1 Function

1.1 Input Voltage Range

- The rated input voltage range of the power supply is AC85-264V (See SPECIFICATIONS for more details).
- To comply with the safety standards, use the power supply with the input voltage range of AC100-240V (50/60Hz).
- If the input voltage is outside the rated range, the power supply may not operate in accordance with the specifications and/or start hunting or fail.
- If the input voltage changes suddenly, the output voltage may go out of the specifications. Consult us for more details.
- When the power supply is used with DC voltage input, an external DC fuse is required for protection. Consult us for more details.

● PLA15F, PLA30F

- Power factor correction is not built-in. If multiple units are used in a same system, the input harmonic current standard may not be met. Consult us more details.

● PLA100F, PLA150F

- If the input voltage is more than AC250V, power factor correction does not work and the power factor deteriorates. Consult us for more details.

● PLA15F, PLA30F, PLA50F, PLA100F, PLA150F

- The power supply is designed to handle instant voltage dip but output power derating is necessary.
 - Use Conditions

Maximum output power	
PLA15F	7.5W
PLA30F	10W
PLA50F	15W
PLA100F	40W
PLA150F	60W

Input AC50V (DC70V)
Duty 1s/30s

*Avoid using the power supply under the above-mentioned conditions for more than 1 second continuously as the power supply may be damaged.

● PLA300F, PLA600F

- The -U option is available for PLA300F and PLA600F to handle instant voltage dip of less than AC85V but output power derating is necessary. (See 5. Options and Others.)

1.2 Inrush Current Limiting

- Inrush current protection is built-in.
- If you need to use a switch on the input side, select one that can withstand an input inrush current.

● PLA15F, PLA30F, PLA50F, PLA100F, PLA150F, PLA300F

- Thermistor is used in the inrush current limiting circuit. When you turn the power supply on and off repeatedly within a short period of time, have enough intervals for the power supply to cool down before being turned on again.

● PLA600F

- Thyristor technique is used in the inrush current limiting circuit. When you turn the power supply on and off repeatedly within a short period of time, have enough intervals for the inrush current protection to become active.
- There will be primary inrush current and secondary inrush current flowing because thyristor technique is used for the inrush current limiting circuit.

1.3 Overcurrent Protection

- Overcurrent protection is built-in. It works at more than 105% of the rated output current. The power supply recovers automatically when the overcurrent condition is removed. Do not use the power supply under a short-circuit or overcurrent condition.
- Intermittent Operation Mode
 - When overcurrent protection works and the output voltage drops, the output voltage goes into intermittent mode so that the average output current can decrease.
- If the power supply is turned on with an overcurrent load, it will immediately go into intermittent mode and may not start up. See the characteristics below. (PLA15F, 30F, 50F, 100F, and 150F)

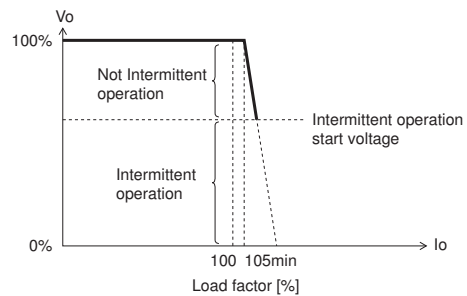

Fig.1.1 Overcurrent protection characteristics

1.4 Overvoltage Protection

- Overvoltage protection is built-in. If overvoltage protection works, shut down the input voltage, wait more than 3 minutes, and turn on the input voltage again to recover the output voltage. The recovery time varies depending on the input voltage, etc.

Remarks :

Avoid applying an overrated voltage to the output terminals as it may cause the power supply to malfunction or fail. In case the above-mentioned situation is expected in operating such loads as a motor, for example, consult us for advice.

1.5 Thermal Protection

● PLA15F, PLA30F, PLA50F, PLA100F, PLA150F

■ These models are not equipped with thermal protection.

● PLA300F, PLA600F

■ Thermal protection is built-in.

Thermal protection will work under the following conditions and the power supply will shut down.

- ① When the operating temperature and the output current greatly exceed the derating curve.
- ② When the built-in cooling fan stops or the air flow from the fan is obstructed.

If thermal protection works, switch off the input voltage and eliminate the conditions causing thermal protection to work. Allow enough time for the unit to cool off before switching on the input voltage again to recover the output voltage.

1.6 Output Ripple and Ripple Noise

■ Output ripple noise may be influenced by the measuring environment. The measuring method shown in Fig. 1.2 is recommended.

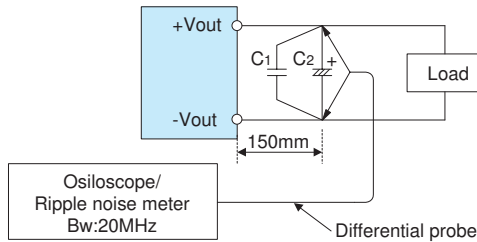

- C1 : Film capacitor 0.1μF
- C2 : Aluminum electrolytic capacitor 22μF

Fig.1.2 Measuring method of Ripple and Ripple Noise

Remarks :

When measuring output ripple or ripple noise with an oscilloscope, do not let the oscilloscope's GND cable cross the magnetic flux from the power supply. Otherwise there may be electrical potential generated on the GND cable and the measuring result may not be accurate.

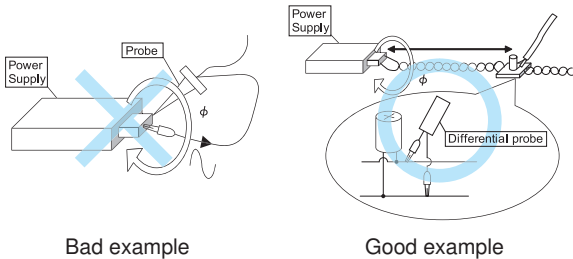

Fig.1.3 Example of measuring output ripple and ripple noise

1.7 Output Voltage Adjustment

■ The output voltage can be adjusted within the specified range by turning the built-in potentiometer clockwise (up) or counterclockwise (down).

■ Please operate the potentiometer slowly.

● PLA300F, PLA600F

■ With the option -V, the power supply comes with an external potentiometer instead of a built-in potentiometer. (See 5 Options and Others).

1.8 Isolation

■ For a receiving inspection, such as Hi-Pot test, gradually increase (decrease) the voltage for the start (shut down). Avoid using Hi-Pot tester with the timer because it may generate voltage a few times higher than the applied voltage, at ON/OFF of a timer.

1.9 Low Power Consumption

● PLA15F, PLA100F, PLA150F

■ These power supplies are designed for low power consumption at no load. (No load power consumption: PLA15F:1.0W typ, PLA100F/150F:1.5W typ)

■ When the load factor is 0 - 35% (PLA15F) and 0- 30% (PLA100F and PLA150F), the switching power loss is reduced by burst operation, which will cause ripple and ripple noise to go beyond the specifications.

■ Ripple and ripple noise during burst operation will change depending on the input voltage and the output current. Consult us for advice on how to reduce ripple and ripple noise.

■ When there is a need to measure the stand-by power consumption, measure it by using the average mode of the tester. The measuring environment may influence the result. Consult us for more details.

1.10 Remote ON/OFF

● PLA15F, PLA30F, PLA50F

■ These models do not have the remote ON/OFF function.

● PLA100F, PLA150F, PLA300F, PLA600F

■ The -R option is available for these models. With the -R option, remote ON/OFF is possible. See "5 Options and Others" for more details.

1.11 Remote Sensing

● PLA15F, PLA30F, PLA50F, PLA100F, PLA150F, PLA300F

■ These models do not have the remote sensing function.

● PLA600F

■ The -W option is available for PLA600F. With the -W option, remote sensing is possible. See "5 Options and Others" for more details.

1.12 LV Alarm

● PLA15F, PLA30F, PLA50F, PLA100F, PLA150F, PLA300F

■ These models do not have the LV alarm function.

● PLA600F

■The -W option is available for PLA600F. With the -W option, the power supply can give an LV alarm. See "5 Options and Others" for more details.

2 Series Operation and Parallel Operation

2.1 Series Operation

■The power supplies can be used in series connection. The output current in series operation must be lower than the rated current of the power supply with the lowest rated current among the power supplies connected in series. Make sure no current exceeding the rated current flows into a power supply.

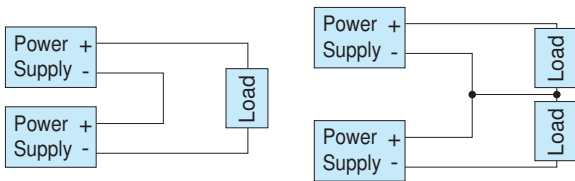

Fig.2.1 Examples of connecting in series operation

2.2 Parallel Operation

■Redundant operation is possible by wiring as shown below.

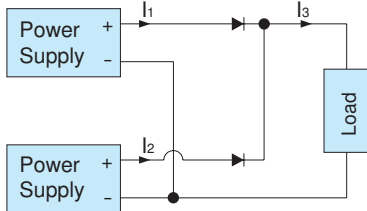

Fig.2.2 Example of redundancy operation

■Even a slight difference in output voltage can affect the balance between the values of I_1 and I_2 . Make sure the value of I_3 does not exceed the rated output current of the power supply.

$$I_3 \leq \text{the rated current value}$$

● PLA15F, PLA30F, PLA50F, PLA100F, PLA150F, PLA300F

■Parallel operation is not possible.

● PLA600F

■The -W option is available for PLA600F. With the -W option, parallel operation is possible. See "5 Options and Others" for more details.

3 Assembling and Installation Method

3.1 Installation Method

■Do not insert a screw more than 6mm away from the outside of a power supply to keep enough insulation distance between the screw and internal components.

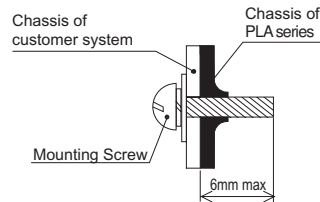
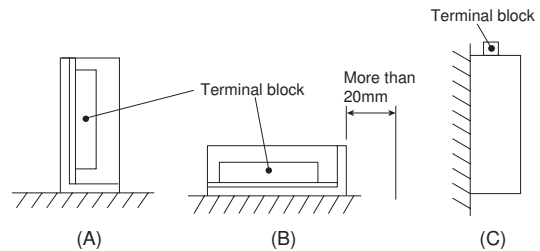

Fig.3.1 Mounting screw

● PLA15F, PLA30F, PLA50F, PLA100F, PLA150F



■If you use two or more power supplies side by side, please keep a sufficient distance between them to allow enough air ventilation.

■Ambient temperature around each power supply should not exceed the temperature range shown in the derating curve.

● PLA300F

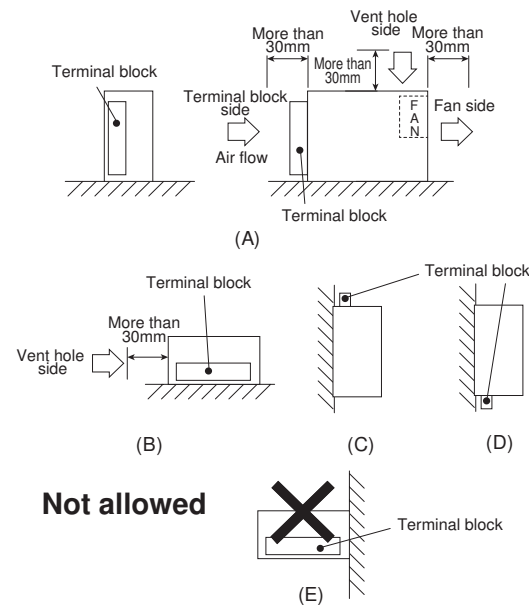

● PLA600F

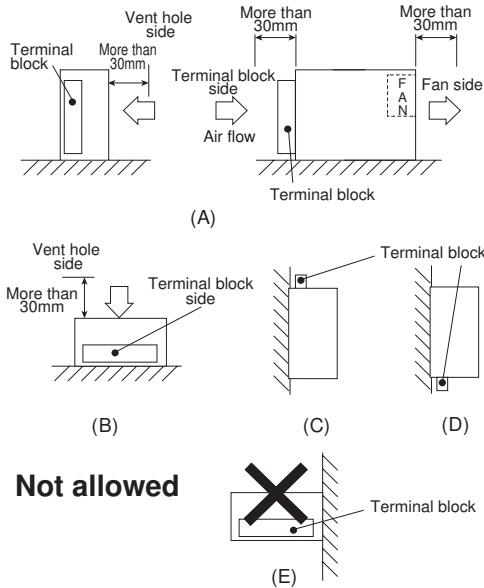

- Avoid installation method (E) as it gives excessive stress to the mounting holes.
- Do not block air flow of the built-in fan (terminal block and ventilation hole).
- If the power supply is used in a dusty environment, use an air-filter. Make sure air flow is not blocked.
- If the built-in fan stops, thermal protection will work and the output will stop. Periodic maintenance of the built-in fan is necessary to enhance the power supply's reliability.
- The expected life (R(t)=90%) of the built-in fan varies depending on the operating condition.

3.2 Derating

■ Input Voltage Derating Curve

The input voltage derating curve is shown in Fig. 3.2.

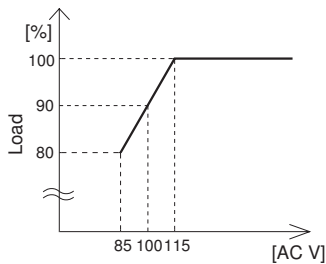

Fig.3.2 Input voltage derating curve

■ Ambient Temperature Derating Curve

The derating curves by the ambient temperature are shown in Fig. 3.3 to Fig. 3.10.

*The specifications of ripple and ripple noise change in the shaded area.

(1) Temperature at Point A and Point B

● PLA15F, PLA30F, PLA50F, PLA100F, PLA150F

- The operating temperature can also be designed by the case temperature with these models. The temperatures in the tables show not the limit of use but the temperature of an expected life.
- Make sure the case temperature at point A and point B is less than the temperatures shown in Fig. 3.1 to Fig. 3.5.
- When the power supply is used with a forced cooling, make sure the case temperature requirements shown in Fig. 3.1 to Fig. 3.5 are met.
- The expected life of the power supply at the highest allowed temperature at point A and point B is 3 years. See "3.3 Expected Life and Warranty" to prolong the expected life. See External View for the position of Point A and Point B.

Table 3.1 Temperature of Point A PLA15F-□

Mounting Method	Load factor	Max temperature [°C]
A, B, C	50% < I_o ≤ 100%	78
	I_o ≤ 50%	85

Table 3.2 Temperature of Point A PLA30F-□

Mounting Method	Load factor	Max temperature [°C]
A	50% < I_o ≤ 100%	80
	I_o ≤ 50%	88
B, C	50% < I_o ≤ 100%	72
	I_o ≤ 50%	82

Table 3.3 Temperature of Point A PLA50F-□

Mounting Method	Load factor	Max temperature [°C]
A	50% < I_o ≤ 100%	78
	I_o ≤ 50%	81
B, C	50% < I_o ≤ 100%	66
	I_o ≤ 50%	71

Table 3.4 Temperature of Point A PLA100F-□

Mounting Method	Load factor	Max temperature [°C]
A, B, C	I_o ≤ 100%	81

Table 3.5 Temperature of Point A, Point B PLA150F-□

Mounting Method	Load factor	Max temperature [°C]	
		Point A	Point B
A, B, C	I_o ≤ 100%	85	78

(2) Derating Curves by Ambient Temperature

■ The derating curve by the ambient temperature shows the operating temperature range for a 3-year continuous use. It shows not the limit of use but the temperature of an expected life. Consult us for the operation limit temperature.

● PLA15F

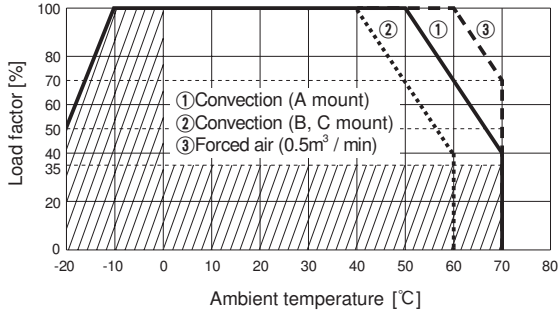

Fig.3.3 Ambient temperature derating curve for PLA15F

● PLA30F

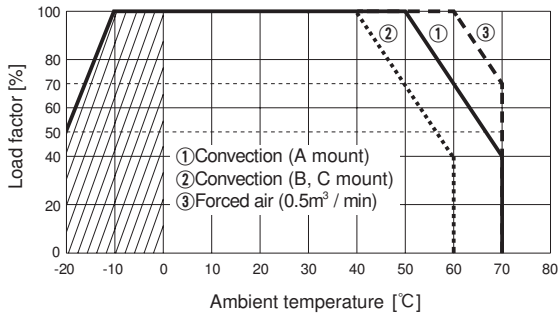

Fig.3.4 Ambient temperature derating curve for PLA30F

● PLA50F

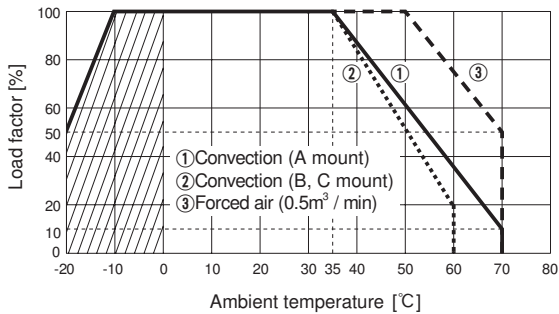

Fig.3.5 Ambient temperature derating curve for PLA50F-5

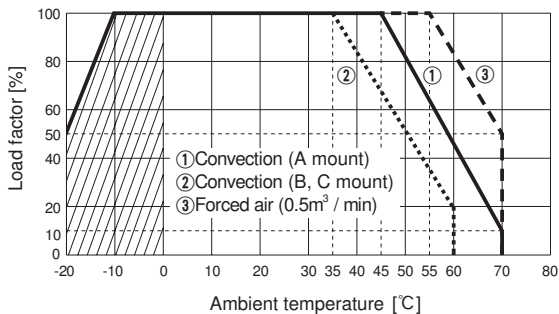

Fig.3.6 Ambient temperature derating curve for PLA50F-12, -15, -24

● PLA100F, PLA150F

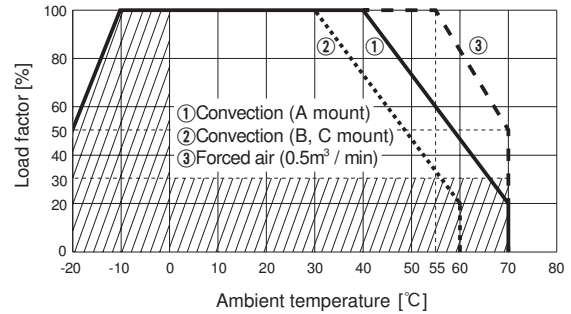

Fig.3.7 Ambient temperature derating curve for PLA100F/150F-12, -15

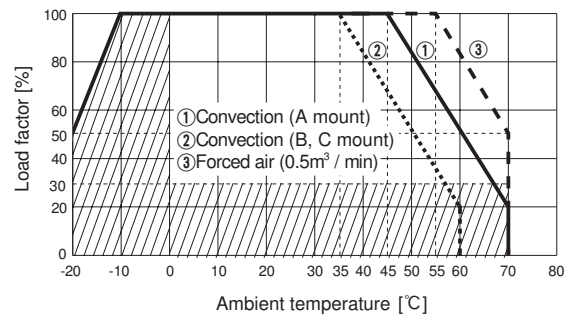

Fig.3.8 Ambient temperature derating curve for PLA100F/150F-24, -36, -48

● PLA15F, PLA30F, PLA50F, PLA100F, PLA150F

■ The ambient temperature should be measured 5 to 10 cm away from the power supply so that it won't be influenced by the heat from the power supply. Please consult us for more details.

● PLA300F

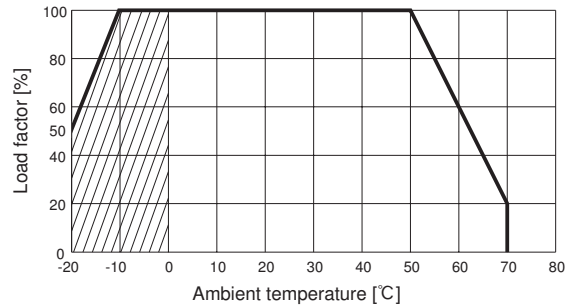

Fig.3.9 Ambient temperature derating curve for PLA300F

● PLA600F

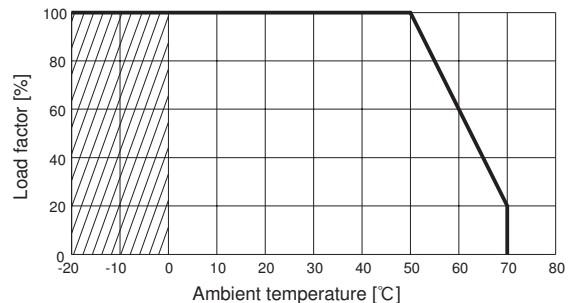

Fig.3.10 Ambient temperature derating curve for PLA600F

● PLA300F, PLA600F

■ The ambient temperature is defined as the temperature of the air (at the terminal block side) that the built-in cooling fan blows into the power supply. Please pay attention to the heat generated by the input and output wires. Please consult us for more details.

3.3 Expected Life and Warranty

■ Expected Life

The expected life of the power supply is shown below.

● PLA15F, PLA30F

Table 3.6 Expected lifetime (PLA15F, PLA30F)

Mounting Method	Cooling Method	Average ambient temperature	Expected lifetime [years]	
			Io ≤ 50%	Io ≤ 100%
A	Convection	Ta = 40°C	7	5
		Ta = 50°C	5	3
B, C	Convection	Ta = 30°C	7	5
		Ta = 40°C	5	3
A, B, C	Forced air cooling	Ta = 50°C	5	5
		Ta = 60°C	5	3

● PLA50F

Table 3.7 Expected lifetime (PLA50F-5)

Mounting Method	Cooling Method	Average ambient temperature	Expected lifetime [years]	
			Io ≤ 50%	Io ≤ 100%
A, B, C	Convection	Ta = 25°C	7	5
		Ta = 35°C	5	3
A, B, C	Forced air cooling	Ta = 40°C	7	5
		Ta = 50°C	7	3

Table 3.8 Expected lifetime (PLA50F-12, -15, -24)

Mounting Method	Cooling Method	Average ambient temperature	Expected lifetime [years]	
			Io ≤ 50%	Io ≤ 100%
A	Convection	Ta = 35°C	7	5
		Ta = 45°C	5	3
B, C	Convection	Ta = 25°C	7	5
		Ta = 35°C	5	3
A, B, C	Forced air cooling	Ta = 45°C	7	5
		Ta = 55°C	7	3

● PLA100F, PLA150F

Table 3.9 Expected lifetime (PLA100F/PLA150F)

Mounting Method	Cooling Method	Average ambient temperature	Expected lifetime [years]	
			Io ≤ 50%	Io ≤ 100%
A	Convection	Ta = 30°C	10	5
		Ta = 40°C	5	3
B, C	Convection	Ta = 20°C	10	5
		Ta = 30°C	5	3
A, B, C	Forced air cooling	Ta = 40°C	10	5
		Ta = 55°C	5	3

● PLA300F, PLA600F

Table 3.10 Expected lifetime (PLA300F/PLA600F)

Mounting	Cooling method	Average ambient temperature	Expected lifetime [years]	
			Io ≤ 50%	Io ≤ 100%
All direction	Forced air cooling (internal fan)	Ta = 30°C	10	7
		Ta = 40°C	7	5
		Ta = 50°C	5	3

* This lifetime includes a built-in fan lifetime.

■ The built-in cooling fan should be changed periodically. The expected life time (R (t) = 90%) of the built-in fan depends on the operating condition as shown in Fig. 3.11.

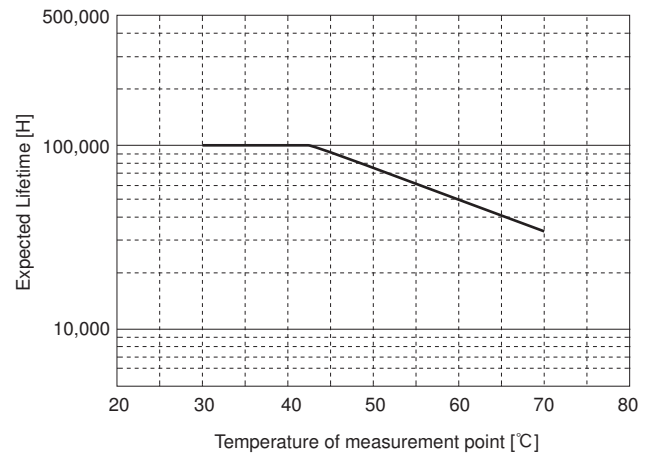

Fig.3.11 Expected lifetime of fan

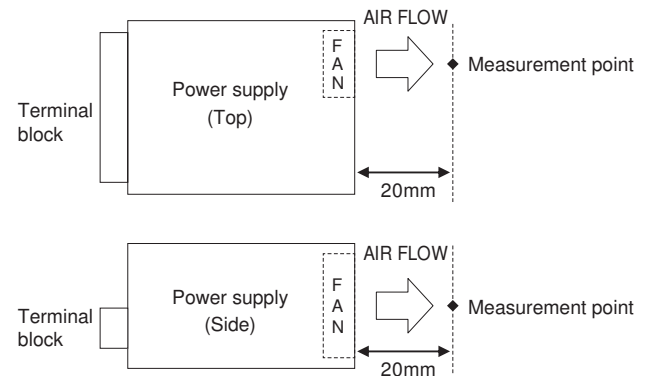

Fig.3.12 Temperature of measurement point for fan lifetime

■Warranty

The maximum warranty period is 5 years as shown in Fig. 3.11 to Fig. 3.15.

● PLA15F, PLA30F

Table 3.11 Warranty (PLA15F/PLA30F)

Mounting	Cooling method	Average ambient temperature	Warranty [years]	
			Io ≤ 50%	Io ≤ 100%
A	Convection	Ta = 40°C	5	5
		Ta = 50°C	5	3
B, C	Convection	Ta = 30°C	5	5
		Ta = 40°C	5	3
A, B, C	Forced air cooling	Ta = 50°C	5	5
		Ta = 60°C	5	3

● PLA50F

Table 3.12 Warranty (PLA50F-5)

Mounting	Cooling method	Average ambient temperature	Warranty [years]	
			Io ≤ 50%	Io ≤ 100%
A, B, C	Convection	Ta = 25°C	5	5
		Ta = 35°C	5	3
A, B, C	Forced air cooling	Ta = 40°C	5	5
		Ta = 50°C	5	3

Table 3.13 Warranty (PLA50F-12, -15, -24)

Mounting	Cooling method	Average ambient temperature	Warranty [years]	
			Io ≤ 50%	Io ≤ 100%
A	Convection	Ta = 35°C	5	5
		Ta = 45°C	5	3
B, C	Convection	Ta = 25°C	5	5
		Ta = 35°C	5	3
A, B, C	Forced air cooling	Ta = 45°C	5	5
		Ta = 55°C	5	3

● PLA100F, PLA150F

Table 3.14 Warranty (PLA100F/PLA150F)

Mounting	Cooling method	Average ambient temperature	Warranty [years]	
			Io ≤ 50%	Io ≤ 100%
A	Convection	Ta = 30°C	5	5
		Ta = 40°C	5	3
B, C	Convection	Ta = 20°C	5	5
		Ta = 30°C	5	3
A, B, C	Forced air cooling	Ta = 40°C	5	5
		Ta = 55°C	5	3

● PLA300F, PLA600F

Table 3.15 Warranty (PLA300F/PLA600F)

Mounting	Cooling method	Average ambient temperature	Warranty [years]	
			Io ≤ 50%	Io ≤ 100%
All direction	Forced air cooling (internal fan)	Ta = 40°C	5	5
		Ta = 50°C	5	3

4 Ground

■When installing the power supply, make sure the FG terminal and the chassis (at more than 2 places) are connected to the safety earth ground.

5 Options and Others

5.1 Outline of Options

● -C (PLA15F, PLA30F, PLA50F, PLA100F, PLA150F, PLA300F, PLA600F)

• With the -C option, the internal PCB has a conformal coating for anti-humidity.

● -G (PLA300F, PLA600F)

• With the -G option, the leakage current of the power supply is reduced.
 • The differences between the option -G models and the standard models are shown below.

Table 5.1 Low leakage current type

Leakage Current (AC240V 60Hz)	0.15mA max
Conducted Noise	N/A
Output Ripple Noise	Please contact us for details about Ripple Noise

* This is the result of measurement of the testing board with capacitors of 22μF and 0.1μF placed at 150 mm from the output terminals by a 20 MHz oscilloscope or a ripple-noise meter equivalent to Keisoku-Giken RM103.

● -V (PLA300F, PLA600F)

• With the -V option, the power supply comes with an external potentiometer connector instead of a built-in potentiometer.
 • The appearance of the -V models is different from that of the standard models. Contact us for more details.
 • Note that if the power supply is turned on with CN3 open, the output voltage will make a big drop.

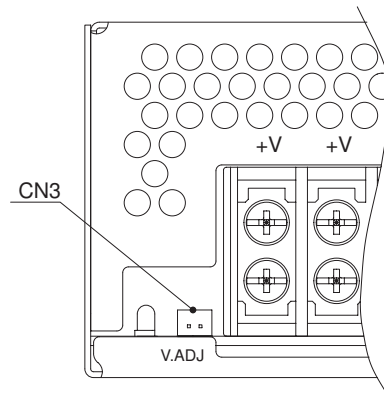

Fig.5.1 Front view of option-V (PLA600F)

● **-U (PLA300F, PLA600F)**

- With the -U option, the power supply can handle an instantaneous input voltage dip (output power derating is required).
- Operating condition (as per SEMI F-47)

Maximum output power *() is 5V output model.

PLA300F	120W (100W)
PLA600F	240W (200W)
Input AC50V	
Duty 1s/30s	

*Do not continue the above-mentioned operating conditions for more than 1 second. Otherwise the power supply may be damaged.

● **-R (PLA100F, PLA150F, PLA300F, PLA600F)**

- The -R option makes it possible to switch on or off the output by applying voltage to the RC terminals of the power supply from an external power source.
- The appearance of the option -R models is different from that of the standard models.
- Designated harnesses for the RC terminals are available for sale. See Optional Parts for more details.
- The -R option models have extra connectors. Please contact us for more details.

Table 5.2 Remote on/off operating conditions

Model Name	Built-in Resistor Ri [Ω]	Voltage between RC and RCG [V]		Input Current [mA]
		Output ON	Output OFF	
PLA100F, PLA150F, PLA300F, PLA600F	780	4.5 - 12.5	0 - 0.5	(20max)

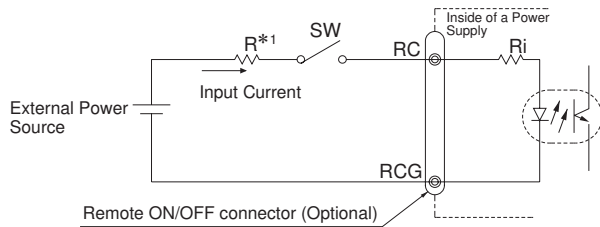

Fig.5.2 Example of using a remote ON/OFF circuit

*1 If the external voltage applied to the -RC terminals is 4.5 -12.5V, the current limiting resistor is not necessary. If the voltage applied is more than 12.5V, make sure the current limiting resistor R is used.

The value of the current limiting resistor is obtained by the following formula:

$$R[\Omega] = \frac{V_{cc} - (1.1 + R_i \times 0.005)}{0.005} \quad V_{cc} : \text{External Power Source}$$

*Note that reversed connection damages internal components of the power supply.

*The remote control circuit is isolated from input, output and FG.

■ Remote on/off control for PLA100F, PLA150F, and PLA300F

- Remote control connectors are added. Contact us for more details.
- Make sure there is an interval of more than 2 seconds in the on/off cycle. If the interval is shorter, the start-up time may become longer (approx. 2 seconds).

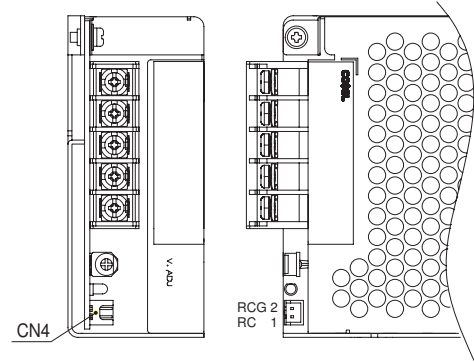

Fig.5.3 Example of option -R (PLA100F, PLA150F)

Table 5.3 Pin configuration and function of CN4

PIN	FUNCTION
1	RC :Remote ON/OFF
2	RCG:Remote ON/OFF (GND)

Table 5.4 Mating connectors and terminals on CN4

Connector	Housing	Terminal	Mfr	
CN4	B2B-XH-AM	XHP-2	BXH-001T-P0.6 or SXH-001T-P0.6	J.S.T.

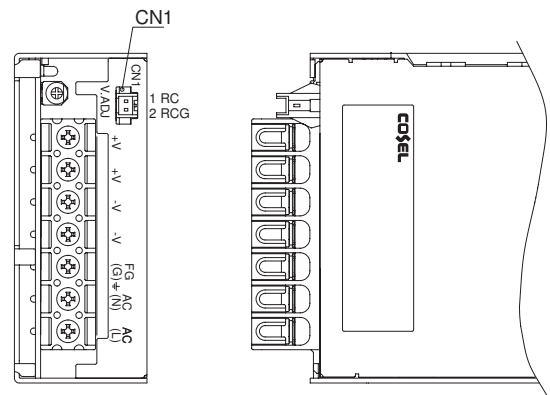

Fig.5.4 Example of option -R (PLA300F)

Table 5.5 Pin configuration and function of CN1

PIN	FUNCTION
1	RC :Remote ON/OFF
2	RCG:Remote ON/OFF (GND)

Table 5.6 Mating connectors and terminals on CN1

Connector	Housing	Terminal	Mfr	
CN1	XARR-02V	XAP-02V-1	SXA-001T-P0.6	J.S.T.

■ Remote on/off control for PLA600F

- The appearance of the -R option model is different from that of the standard model as CN1 is added. Contact us for more details.

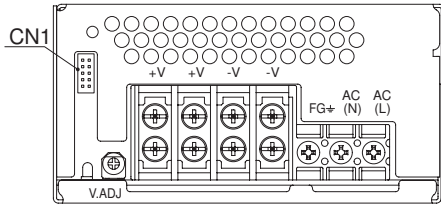

Fig.5.5 Front view of option -R (PLA600F)

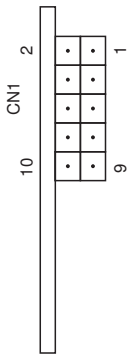

Fig.5.6 Pin number

Table 5.7 Pin configuration and function of CN1

PIN	FUNCTION
1	- :N.C.
2	- :N.C.
3	RC :Remote ON/OFF
4	RCG:Remote ON/OFF(GND)
5	- :N.C.
6	- :N.C.
7	- :N.C.
8	- :N.C.
9	- :N.C.
10	- :N.C.

Table 5.8 Mating connectors and terminals on CN1

Connector	Housing	Terminal	Mfr
CN1	S10B-PHDSS	PHDR-10VS	Reel :SPHD-002T-P0.5
			Loose :BPHD-001T-P0.5
			:BPHD-002T-P0.5
		J.S.T.	

● -W (PLA600F only)

- The -W option model provides remote sensing, low output voltage alarm (LV alarm), and parallel operation.
- The appearance of the -W option model is different from that of the standard mode. Contact us for more details.
- Designated harnesses are available for sale. See Optional Parts.
- The differences from the standard model are shown in Fig. 5.9.

Table 5.9 Specification differences of Option -W

Load regulation	1.5 times of standard spec.
Ripple	1.5 times of standard spec.
Ripple noise	1.5 times of standard spec.

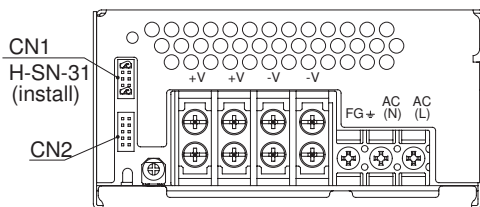

Fig.5.7 Front view of option -W

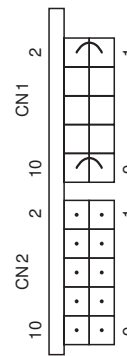

Fig.5.8 Pin number

Table 5.10 Pin configuration and function of CN1 and CN2

PIN	FUNCTION
1	+M :Self sensing terminal (Don't wire for external function)
2	+S :+Sensing
3	- :N.C.
4	- :N.C.
5	LV :LV alarm
6	LVG :LV alarm (GND)
7	CB :Current balance
8	- :N.C.
9	-M :Self sensing terminal (Don't wire for external function)
10	-S :-Sensing

Table 5.11 Mating connectors and terminals on CN1 and CN2

Connector	Housing	Terminal	Mfr
CN1 CN2	S10B-PHDSS	PHDR-10VS	Reel :SPHD-002T-P0.5
			Loose :BPHD-001T-P0.5
			:BPHD-002T-P0.5
		J.S.T.	

■ LV alarm

The operating conditions of the LV alarm are shown in Table 5.12. The internal circuit of the LV alarm is shown in Fig. 5.9. The LV alarm is isolated from input, output, and FG.

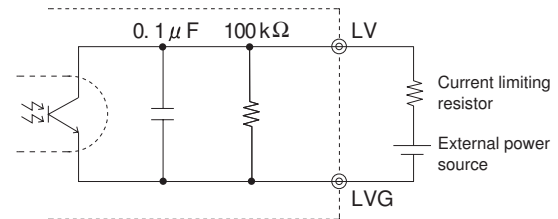

Fig.5.9 LV internal circuit

Table 5.12 LV alarm operating conditions

	Alarm	Output of alarm
LV	If the output voltage drops or stops, the LV and LVG terminals give an alarm signal. Note : ①In case of overcurrent, the alarm signal will be unstable. ②The alarm signal won't be given in parallel operation if OR diodes are not used.	Open collector method Good : Low (0 - 0.8V, 10mA max) Fail : High or Open 50V 10mA max

■ Parallel operation

For parallel operation, please take the following steps:

- ① (Before wiring) set the output voltage of each unit to the desired value. The output voltage difference between the units must be less than 0.1V or 1% of the rated output voltage, whichever is smaller.
- ② Wire the power supplies as shown in Fig. 5.10. Make sure the output wires of the units connected in parallel are of the same length and the same type.

- ③ Make sure the total output current does not exceed the value determined by the following formula:

$$\left[\begin{array}{l} \text{Output current in} \\ \text{parallel operation} \end{array} \right] = \left[\begin{array}{l} \text{The rated} \\ \text{current per unit} \end{array} \right] \times (\text{Number of unit}) \times 0.85$$

*Make sure the current drawn from each unit is less than the rated output current.

- When adjusting the output voltage after wiring, repeat the above-mentioned steps (① to ④).
- If the number of units in parallel increases, the input current increases as well. Make sure the input equipment and wires have enough current capacity.
- The maximum number of units for parallel connection is 5.
- Master-Booster operation is not possible.

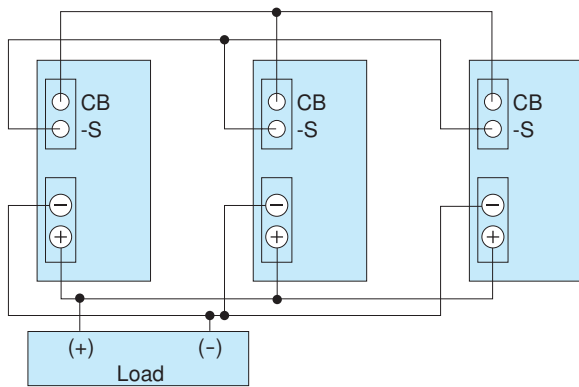

Fig.5.10 Parallel operation condition

- If the output current is less than 10% of the rated output current, the output voltage may fluctuate. The required minimum current is different depending on the model and the number of units in parallel. Consult us for more details.
- If the length of the output wires of each unit is different, the output current from each unit will be unbalanced. Make sure to use output wires of the same length for all units in parallel.

■ Remote sensing

- These models are equipped with a remote sensing function. If the remote sensing is not used, the following terminals of CN1 must be shorted:

+S and +M
-S and -M

When the power supply is shipped from our factory, a designated harness (H-SN-31) is attached to CN1. If remote sensing is not used, there is no need to remove the harness.

- The wire connection when remote sensing is used or not used is shown in Fig. 5.11 - Fig. 5.12.
- When using remote sensing, make sure to finish wiring +S and -S first. The designated harness is available for sale. Contact us for more details.
- When using remote sensing, pay attention to the following:

- ① Wiring must be done carefully. If there is bad connection on the load lines due to loose screws, etc., the load current flows into the sensing lines and the internal circuit of the power supply may be damaged.

- ② Make sure the wires between the load and the power supply are thick enough to keep the line drop less than 0.3V.
- ③ If the sensing wires are long, place C1 and R1 across the load lines.
- ④ Use a twisted pair wire or a shielded wire for the sensing lines.
- ⑤ Do not draw the output current from +M, -M, +S or -S.
- ⑥ The impedance of the wiring or the load may cause the output voltage to oscillate or fluctuate.

Test to confirm remote sensing works fine. If the output voltage is found to be unstable, the following methods are recommended:

- Remove the remote sensing line on the minus side and short -S and -M.
- Use C1, R1, and R2.

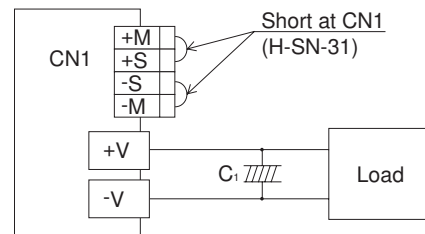

Fig.5.11 When not using remote sensing function

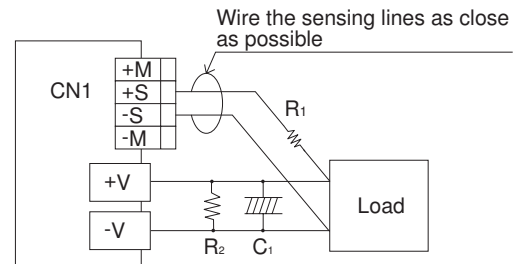

Fig.5.12 When using remote sensing function

● -T (PLA15F, PLA30F, PLA50F, PLA100F, PLA150F)

- The -T option models come with a vertical terminal block. The appearance is different from that of the standard models. Contact us for more details.

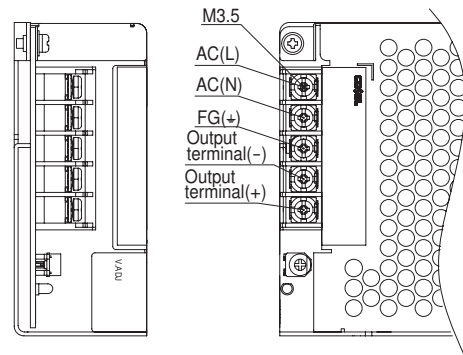

Fig.5.13 Example of option -T(PLA100F)

● -T2 (PLA300F, PLA600F)

- The -T2 option models come with a normal (non-screw-hold type) terminal block. The appearance is different from that of the standard models. Contact us for more details.

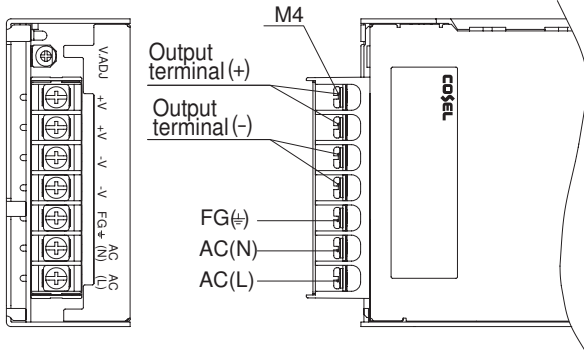

Fig.5.14 Example of option -T2(PLA300F)

● -J (PLA15F, PLA30F, PLA50F, PLA100F, PLA150F)

- The -J option models come with AMP connectors instead of a terminal block.
- The designated harnesses are available for sale. See Optional Parts for more details.
- The appearance is different from that of the standard models. Contact us for more details.
- Keep the drawing current less than 5A per pin.
- UL508 does not apply to the -J option models.

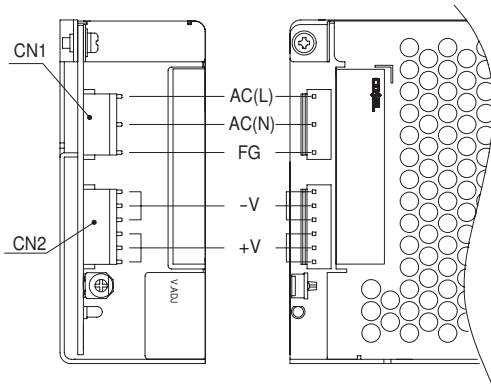

Fig.5.15 Example of option -J (PLA100F)

Table 5.13 Mating connectors and terminals on CN1 and CN2 in option -J (PLA15F, PLA30F, PLA50F)

I/O Connector	Matching Housing	Terminal
CN1	1-1123724-3	Reel : 1123721-1
		Loose : 1318912-1
CN2	1-1123723-4	Reel : 1123721-1
		Loose : 1318912-1

(Mfr. Tyco electronics AMP)

Table 5.14 Mating connectors and terminals on CN1 and CN2 in option -J (PLA100F, PLA150F)

I/O Connector	Matching Housing	Terminal
CN1	1-1123724-3	Reel : 1123721-1
		Loose : 1318912-1
CN2	1-1123723-6	Reel : 1123721-1
		Loose : 1318912-1

(Mfr. Tyco electronics AMP)

● -L (PLA100F, PLA150F)

- With the -L option models, power consumption at no load is smaller than that of the standard models.

[Power consumption at no load]

Option -L : 0.5W max

Standard model (Reference) : 1.5W typ

Condition: AC240V input, I_o=0A

- When the ambient temperature is from -10°C to -20°C, use the power supply with the input voltage range of AC115-264V.
- Make sure to have 1-second interval from turning off to turning on again. If the interval is shorter, the output voltage may hunt.
- The dynamic load response (I_o=0%-100%) is different from that of the standard models. Test to confirm the actual voltage change in the final application before using.

● -F4 (PLA300F, PLA600F)

- The -F4 option models come with a low-speed fan to reduce the fan noise.
- The differences from the standard fan versions are shown in Fig. 5.16 and Fig. 5.17.

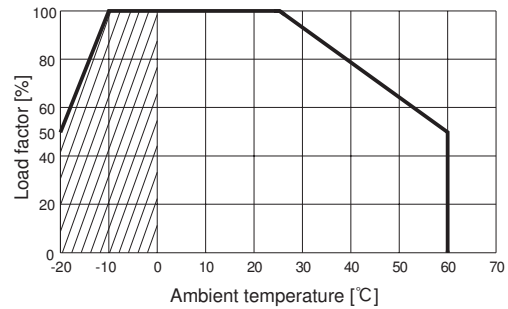

Fig.5.16 Ambient temperature derating curve for PLA300F (Option-F4)

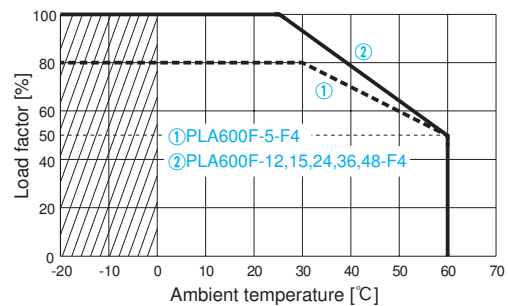

Fig.5.17 Ambient temperature derating curve for PLA600F (Option-F4)

● –N1 (PLA15F, PLA30F, PLA50F, PLA100F, PLA150F)

- The –N1 option models come with a DIN rail mount attachment.
- The appearance is different from that of the standard models. Contact us for more details.
- The –N1 option models have different vibration and shock specifications. Consult us for more details.
- Contact us for safety agency approvals.

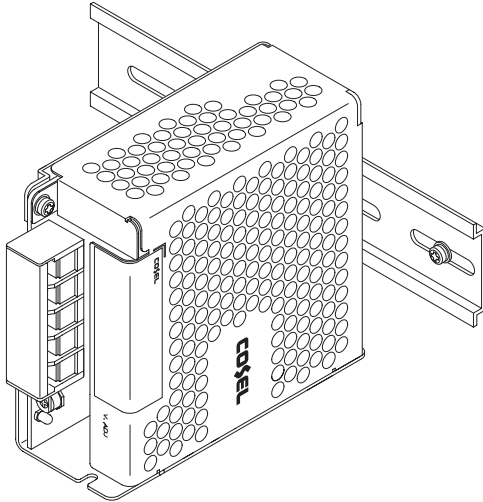

Fig.5.18 Power supply installed on a DIN rail (PLA100F)

5.2 Others

- Note that the case of the power supply remains hot for a while after it is turned off.
- If large capacitors are connected to the output terminals (load side), the output voltage may stop or become unstable. Consult us for advice.
- If the power supply is turned off at no load, the output voltage remains for a few minutes as the power supply is designed for low internal power consumption. Be careful of electrical shock at the time of maintenance.
- If the built-in cooling fan in PLA300F/PLA600F stops, the built-in thermal protection may work and the output voltage may stop. Periodic maintenance of the built-in fan is necessary to enhance the power supply's reliability.
- When more than two units are connected in parallel at the input, the total capacitance between the lines becomes larger and a discharge resistance may be necessary to meet the safety agency approvals. Consult us for advice.

FORTEC

ELEKTRONIK AG

Our company network supports you worldwide with offices in Germany, Austria, Switzerland, Great Britain and the USA. For more information please contact:

FORTEC Elektronik AG

Hauptniederlassung
Lechwiesenstr. 9
86899 Landsberg am Lech

Telefon: +49 (0) 8191 91172-0
Telefax: +49 (0) 8191 21770
E-Mail: sales@fortecag.de
Internet: www.fortecag.de

FORTEC Elektronik AG

Büro Nord
Am Hasenkamp 36
22457 Hamburg

Telefon: +49 (0) 40 54 80 56 11
Telefax: +49 (0) 40 54 80 56 13
E-Mail: nord@fortecag.de
Internet: www.fortecag.de

FORTEC Elektronik AG

Büro West
Hohenstaufenring 55
50674 Köln

Telefon: +49 (0) 221 272 273-0
Telefax: +49 (0) 221 272 273-10
E-Mail: west@fortecag.de
Internet: www.fortecag.de

FORTEC Elektronik AG

Büro Wien
Nuschinggasse 12
A-1230 Wien

Telefon: +43 1 8673492-0
Telefax: +43 1 8673492-26
E-Mail: office@fortec.at
Internet: www.fortec.at

ALTRAC AG

(Tochter der Fortec AG):
Bahnhofstraße 3
CH-5436 Würenlos

Telefon: +41 (0) 44 7446111
Telefax: +41 (0) 44 7446161
E-Mail: info@altrac.ch
Internet: www.altrac.ch

Members of the FORTEC Group:

